

# Yealink



## Yealink Gigabit Color IP Phone SIP-T46S User Guide

Version 81.70  
Mar. 2017

# Copyright

**Copyright © 2017 YEALINK(XIAMEN) NETWORK TECHNOLOGY CO., LTD.**

Copyright © 2017 Yealink(Xiamen) Network Technology CO., LTD. All rights reserved. No parts of this publication may be reproduced or transmitted in any form or by any means, electronic or mechanical, photocopying, recording, or otherwise, for any purpose, without the express written permission of Yealink(Xiamen) Network Technology CO., LTD. Under the law, reproducing includes translating into another language or format.

When this publication is made available on media, Yealink(Xiamen) Network Technology CO., LTD. gives its consent to downloading and printing copies of the content provided in this file only for private use but not for redistribution. No parts of this publication may be subject to alteration, modification or commercial use. Yealink(Xiamen) Network Technology CO., LTD. will not be liable for any damages arising from use of an illegally modified or altered publication.

## Warranty

THE SPECIFICATIONS AND INFORMATION REGARDING THE PRODUCTS IN THIS GUIDE ARE SUBJECT TO CHANGE WITHOUT NOTICE. ALL STATEMENTS, INFORMATION, AND RECOMMENDATIONS IN THIS GUIDE ARE BELIEVED TO BE ACCURATE AND PRESENTED WITHOUT WARRANTY OF ANY KIND, EXPRESS OR IMPLIED. USERS MUST TAKE FULL RESPONSIBILITY FOR THEIR APPLICATION OF PRODUCTS.

YEALINK(XIAMEN) NETWORK TECHNOLOGY CO., LTD. MAKES NO WARRANTY OF ANY KIND WITH REGARD TO THIS GUIDE, INCLUDING, BUT NOT LIMITED TO, THE IMPLIED WARRANTIES OF MERCHANTABILITY AND FITNESS FOR A PARTICULAR PURPOSE. Yealink(Xiamen) Network Technology CO., LTD. shall not be liable for errors contained herein nor for incidental or consequential damages in connection with the furnishing, performance, or use of this guide.

## Declaration of Conformity



Hereby, Yealink(Xiamen) Network Technology CO., LTD. declares that this phone is in conformity with the essential requirements and other relevant provisions of the CE, FCC.

You can find the CE and FCC information from the label on the back of the IP phone.

Statements of compliance can be obtained by contacting [support@yealink.com](mailto:support@yealink.com).

## CE Mark Warning

This device is marked with the CE mark in compliance with EC Directives 2014/35/EU and 2014/30/EU.

## Part 15 FCC Rules

Any changes or modifications not expressly approved by the party responsible for compliance could void the user's authority to operate the equipment.

This device complies with Part 15 of the FCC Rules. Operation is subject to the following two conditions:

1. This device may not cause harmful interference, and

2. this device must accept any interference received, including interference that may cause undesired operation.

## Industry Canada (IC)

This Class [B] digital apparatus complies with Canadian ICES-003 and ICCS-03 Part V Rules

## Class B Digital Device or Peripheral

Note: This equipment has been tested and found to comply with the limits for a Class B digital device, pursuant to part 15 of the FCC Rules. These limits are designed to provide reasonable protection against harmful interference in a residential installation. This equipment generates, uses and can radiate radio frequency energy and, if not installed and used in accordance with the instructions, may cause harmful interference to radio communications. However, there is no guarantee that interference will not occur in a particular installation. If this equipment does cause harmful interference to radio or television reception, which can be determined by turning the equipment off and on, the user is encouraged to try to correct the interference by one or more of the following measures:

1. Reorient or relocate the receiving antenna.
2. Increase the separation between the equipment and receiver.
3. Connect the equipment into an outlet on a circuit different from that to which the receiver is connected.
4. Consult the dealer or an experienced radio/TV technician for help.

## WEEE Warning



To avoid the potential effects on the environment and human health as a result of the presence of hazardous substances in electrical and electronic equipment, end users of electrical and electronic equipment should understand the meaning of the crossed-out wheeled bin symbol. Do not dispose of WEEE as unsorted municipal waste and have to collect such WEEE separately.



## Customer Feedback

We are striving to improve our documentation quality and we appreciate your feedback. Email your opinions and comments to [DocsFeedback@yealink.com](mailto:DocsFeedback@yealink.com).

## GNU GPL INFORMATION

Yealink SIP-T46S IP phone firmware contains third-party software under the GNU General Public License (GPL). Yealink uses software under the specific terms of the GPL. Please refer to the GPL for the exact terms and conditions of the license.

The original GPL license, source code of components licensed under GPL and used in Yealink products can be downloaded online:

<http://www.yealink.com/GPLOpenSource.aspx?BaseInfoCateId=293&NewsCateId=293&CateId=293>.



## About This Guide

Thank you for choosing the SIP-T46S IP phone, an ultra-elegant Gigabit IP phone which is exquisitely designed to provide business telephony features, such as Call Hold, Call Transfer, Busy Lamp Field, Multicast Paging and Conference over an IP network.

This guide provides everything you need to quickly use your new phone. First, verify with your system administrator that the IP network is ready for phone configuration. Also be sure to read the Packaging Contents and Regulatory Notices sections in this guide before you set up and use the SIP-T46S IP phone.

**Note**

Network Directory and Network Call Log features are hidden for IP phones in neutral firmware version, which are designed for the BroadWorks environment. Please contact your system administrator for more information.

## In This Guide

Topics provided in this guide include:

- [Chapter 1 Overview](#)
- [Chapter 2 Getting Started](#)
- [Chapter 3 Customizing Your Phone](#)
- [Chapter 4 Basic Call Features](#)
- [Chapter 5 Advanced Phone Features](#)

## Summary of Changes

This section describes the changes to this guide for each release and guide version.

### Changes for Release 81, Guide Version 81.70

The following section is new:

- [Parking a Call/Retrieving a Parked Call to the Monitored User](#) on page 168

Major updates have occurred to the following sections:

- [Entering Data and Editing Fields](#) on page on page 36
- [Configuring an Access URL](#) on page 76
- [DSS Keys](#) on page 89

- [Auto Answer](#) on page 121
- [Do Not Disturb \(DND\)](#) on page 128
- [Call Forward](#) on page 133
- [Call Park/Retrieve](#) on page 148
- [Configuring Visual and Audio Alert for BLF Pickup](#) on page 162
- [Receiving RTP Stream](#) on page 188

BLF Ring Type is moved to [Configuring Visual and Audio Alert for BLF Pickup](#) on page 162.

## Changes for Release 81, Guide Version 81.20

Major updates have occurred to the following sections:

- [Wallpaper](#) on page 39
- [Screen Saver](#) on page 41

# Table of Contents

## About This Guide ..... v

In This Guide .....	v
Summary of Changes .....	v
Changes for Release 81, Guide Version 81.70 .....	v
Changes for Release 81, Guide Version 81.20 .....	vi

## Table of Contents..... vii

## Overview ..... 1

Hardware Component Instructions .....	1
Icon Instructions .....	3
Feature Status Icons .....	3
Line Key Icons .....	4
Other Icons .....	8
LED Instructions .....	9
User Interfaces .....	11
Phone User Interface .....	12
Web User Interface .....	12
Documentations .....	15

## Getting Started..... 17

Packaging Contents .....	17
Optional Accessories .....	18
Phone Installation .....	20
Network Connection .....	23
Connecting to the Wired Network .....	24
Connecting to the Wireless Network .....	24
Phone Initialization .....	24
Phone Status .....	25
Basic Network Settings .....	26
Wireless Network Settings .....	28
Activating the Wi-Fi Mode .....	29
Connecting to the Wireless Network .....	29
Viewing the Wireless Network Information .....	32
Managing the Saved Wireless Network .....	33
Disconnecting the Wireless Network Connection .....	34

Deactivating the Wi-Fi Mode.....	34
Registration.....	34
Idle Screen.....	35
Entering Data and Editing Fields.....	36
<b>Customizing Your Phone.....</b>	<b>39</b>
General Settings.....	39
Wallpaper.....	39
Screen Saver.....	41
Power Saving.....	43
Backlight.....	46
Contrast.....	47
Language.....	47
Time & Date.....	48
Administrator Password.....	50
Key As Send.....	51
Phone Lock.....	52
Audio Settings.....	55
Volume.....	55
Ring Tones.....	56
Key Tone.....	58
Contact Management.....	59
Directory.....	59
Local Directory.....	61
Blacklist.....	74
Remote Phone Book.....	76
Call History Management.....	78
Viewing History Records.....	78
Placing a Call from History Records.....	79
Adding a Contact to the Local Directory/Blacklist.....	79
Deleting History Records.....	79
Disabling History Record.....	80
Search Source List in Dialing.....	80
System Customizations.....	82
Headset Use.....	82
Bluetooth Headset.....	84
DSS Keys.....	89
Account Management.....	103
Dial Plan.....	106
Emergency Number.....	112
Live Dialpad.....	113
Hotline.....	113

## **Basic Call Features.....115**

Placing Calls .....	115
Answering Calls.....	118
Ending Calls.....	119
Redialing Numbers.....	119
Recent Call In Dialing .....	119
Auto Answer.....	121
Auto Redial .....	122
Call Completion .....	123
ReCall .....	125
Call Mute .....	125
Muting a Call .....	126
Muting While Dialing .....	126
Call Hold/Resume .....	127
Do Not Disturb (DND).....	128
Call Forward .....	133
Static Forwarding .....	133
Dynamic Forwarding .....	141
Call Transfer.....	141
Blind Transfer.....	142
Semi-attended Transfer.....	143
Attended Transfer.....	144
Call Waiting .....	144
Conference .....	145
Local Conference .....	145
Network Conference.....	147
Call Park/Retrieve.....	148
FAC Mode .....	149
Transfer Mode.....	152
Call Pickup .....	153
Directed Call Pickup.....	154
Group Call Pickup .....	156
Anonymous Call .....	158
Anonymous Call Rejection .....	159

## **Advanced Phone Features.....161**

Busy Lamp Field (BLF).....	161
Configuring the BLF Feature on the IP Phone.....	161
Using BLF Feature on the IP Phone .....	166
BLF List .....	168
Call Recording .....	170
Recording Using a USB Flash Drive .....	171

Recording Using a Record Key .....	176
Hot Desking .....	179
Intercom .....	180
Configuring the Intercom Feature on the IP Phone.....	181
Using Intercom .....	183
Multicast Paging.....	184
Sending RTP Stream .....	184
Receiving RTP Stream .....	188
Using Multicast Paging.....	190
Music on Hold .....	191
Automatic Call Distribution (ACD) .....	192
Shared Call Appearance (SCA).....	194
Configuring SCA Feature on the IP Phone .....	195
Using SCA Feature on the IP Phone .....	201
Bridged Lines Appearance (BLA).....	207
Configuring BLA Feature on the IP Phone.....	208
Using BLA Feature on the IP Phone.....	211
Messages.....	213
Short Message Service (SMS).....	213
Voice Mail .....	215
Message Waiting Indicator (MWI) .....	217
<b>Regulatory Notices .....</b>	<b>221</b>
Service Agreements .....	221
Limitations of Liability .....	221
Safety Instructions .....	221
<b>Appendix.....</b>	<b>223</b>
Appendix A - Time Zones.....	223
Appendix B - Menu Structure.....	225
<b>Index .....</b>	<b>227</b>

## Overview

This chapter provides the overview of the SIP-T46S IP phone. Topics include:

- [Hardware Component Instructions](#)
- [Icon Instructions](#)
- [LED Instructions](#)
- [User Interfaces](#)
- [Documentations](#)





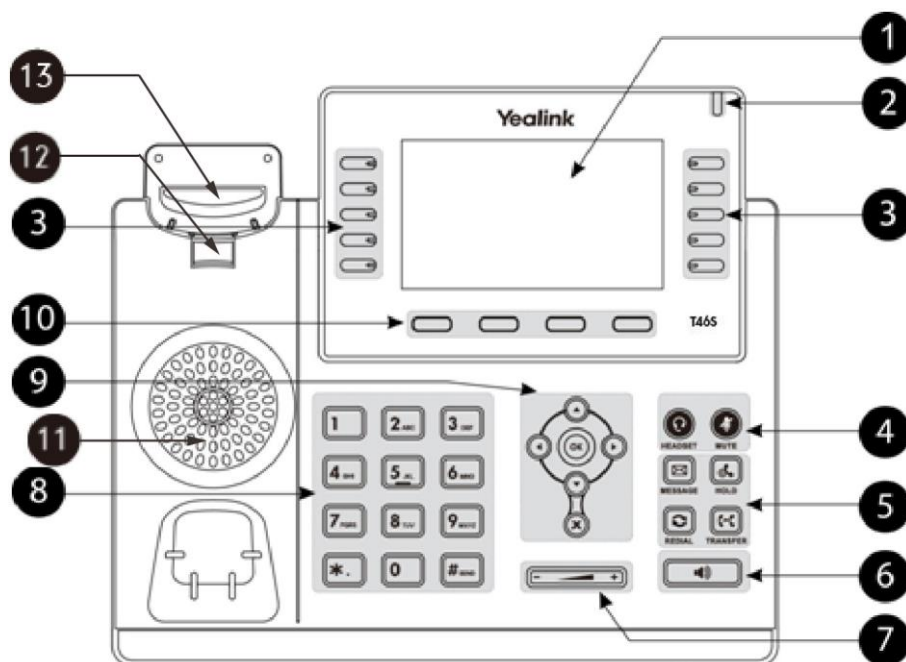

If you require additional information or assistance with your new phone, contact your system administrator.

## Hardware Component Instructions

The main hardware components of the SIP-T46S IP phone are the LCD screen and the keypad.



Hardware component instructions of the SIP-T46S IP phone are:

	Item	Description
①	LCD Screen	Shows information about calls, messages, soft keys, time, date and other relevant data: <ul style="list-style-type: none"> <li>• Default account</li> <li>• Call information—caller ID, call duration</li> <li>• Icons (for example, )</li> <li>• Missed call text or second incoming caller information</li> <li>• Prompt text (for example, "Saving config file!")</li> <li>• Time and date</li> </ul>
②	Power Indicator LED	Indicates call status, message status and phone's system status. <ul style="list-style-type: none"> <li>• Receives an incoming call—Fast-flashing</li> <li>• Receives a voice mail or text message—Slow-flashing</li> </ul>
③	Line Keys	Use these keys to activate up to sixteen accounts and assign various features.
④	HEADSET Key	Toggles and indicates the headset mode.
	MUTE Key	Toggles and indicates mute feature.
⑤	MESSAGE Key	Accesses voice messages.
	HOLD Key	Places a call on hold or resumes a held call.
	REDIAL Key	Redials a previously dialed number.
	TRANSFER Key	Transfers a call to another party.
⑥	Speakerphone Key	Toggles and indicates the hands-free (speakerphone) mode. The key LED illuminates solid green when hands-free (speakerphone) mode is activated.
⑦	Volume Key	Adjusts the volume of the handset, headset, speaker, ringer or media.
⑧	Keypad	Provides the digits, letters and special characters in context-sensitive applications.
⑨	   	Scroll through the displayed information.
		Confirms actions or answers incoming calls.
		Cancels actions or rejects incoming calls.
⑩	Soft Keys	Label automatically to identify their context-sensitive features.
⑪	Speaker	Provides hands-free (speakerphone) audio output.
⑫	Hookswitch Tab	Secures the handset in the handset cradle when the IP phone is mounted vertically. For more information on how to adjust the hookswitch tab, refer to <a href="#">Yealink Wall Mount Quick Installation Guide for Yealink IP Phones</a> .





















	Item	Description
⑬	Hookswitch	<ul style="list-style-type: none"> <li>• Picking up the handset from the handset cradle, the hookswitch bounces and the phone connects to the line.</li> <li>• Laying the handset down on the handset cradle, the phone disconnects from the line.</li> </ul>

## Icon Instructions

### Feature Status Icons



Icons appearing on the status bar are described in the following table:











Icons	Description
	Network is unavailable
	Hands-free (speakerphone) mode
	Handset mode
	Headset mode
	Voice Mail
	Text Message
	Auto Answer
	Do Not Disturb (DND)
	Keep Mute
	Ringer volume is 0
	Phone Lock
	Missed Calls
	Call Forward
	Recording starts successfully (Using a USB flash drive)

Icons	Description
	Recording is paused (Using a USB flash drive)
	Bluetooth mode is on
	Bluetooth headset is both paired and connected
	Wi-Fi connection is successful
	Wi-Fi connection failed







## Line Key Icons

**Icon indicator** (associated with line key features)

Icons	Description
	Hold/Public Hold Private Hold
	DND
	Voice Mail
	SMS
	Direct Pickup
	Group Pickup
	DTMF Prefix
	Local Group XML Group
	LDAP
	XML Browser
	Conference
	Forward
	Transfer



Icons	Description
	ReCall
	Record URL Record
	Recording starts successfully (Record/URL Record)
	Multicast Paging Group Listening Paging List
	Hot Desking
	Zero Touch
	URL
	Phone Lock
	Directory
	Speed Dial

**Icon indicator** (associated with line)





Icons	Description
	The private line registers successfully
	The shared/bridged line registers successfully
	Registering
	Register failed
	DND is enabled on this line
	Call forward is enabled on this line

**Icon indicator** (associated with call park/retrieve park)





Icons	Description
	Call Park (Park successfully; Call park idle state)

Icons	Description
	Call Park (Park failed)
	Call Park (Call park ringing state)
	Retrieve Park



**Icon indicator** (associated with ACD)





Icon	Description
	Logged in the ACD system
	The ACD status is available
	The ACD state is Wrap up
	The ACD status is unavailable
	Log out of the ACD system

**Icon indicator** (associated with intercom)

Icons	Description
	Intercom idle state
	Intercom ringing state
	Intercom callout/talking state
	Intercom failed state











**Icon indicator** (associated with BLF/BLF List)

Icons	Description
	BLF/BLF List idle state
 (Flashing)	BLF/BLF list ringing state
	BLF/BLF list callout state

Icons	Description
(Flashing)	
	BLF/BLF list talking state
	BLF hold state
	BLF list call park state
	BLF/BLF List failed state







**Icon indicator** (associated with a shared line)

The local SCA phone indicates the phone is involved in an SCA call, while the monitoring SCA phone indicates the phone is not involved in the SCA call.

Icon	Description
	The shared line is idle.
 (for monitoring SCA phone)	The shared line is seized.
	The shared line receives an incoming call.
	The shared line is dialing.
	The shared line is in conversation.
	The shared line conversation is placed on public hold.
 (for local SCA phone)  (for monitoring SCA phone)	The shared line conversation is placed on private hold.
	The shared line conversation is barged in by the other shared line party.
	For a multi-party call, all the shared line parties participating in this call place the shared line conversation on hold.





**Icon indicator** (associated with a bridged line)

The local BLA phone indicates the phone is involved in a BLA call, while the monitoring BLA phone indicates the phone is not involved in the BLA call.

Icon	Description
	The bridged line is idle.
 (for monitoring BLA phone)	The bridged line is seized.
	The bridged line receives an incoming call.
	The bridged line is dialing.
	The bridged line is in conversation.
	The bridged line conversation is placed on hold.



## Other Icons

**Icon indicator** (associated with call recording)



Icon	Description
	Recording box is full (Using a record key)
	A call cannot be recorded (Using a record key)
	Recording starts successfully (Using a record key)
	Recording cannot be started (Using a record key)
	Recording cannot be stopped (Using a record key)

**Icon indicator** (associated with call history)

Icon	Description
	Received Calls

Icon	Description
	Placed Calls
	Missed Calls
	Forwarded Calls

**Icon indicator** (associated with contact)

Icon	Description
	Contact icon
	The default caller photo

## LED Instructions

### Power Indicator LED

LED Status	Description
Solid red	The phone is initializing.
Fast-flashing red (300ms)	The phone is ringing.
Slow-flashing red (1s)	The phone receives a voice mail or text message.
Off	<ul style="list-style-type: none"> <li>The phone is powered off.</li> <li>The phone is idle.</li> <li>The phone is busy.</li> <li>The call is placed on hold or is held.</li> <li>The call is muted.</li> </ul>

### Line key LED

LED Status	Description
Solid green	<ul style="list-style-type: none"> <li>The line is seized.</li> <li>The line is in conversation.</li> </ul>
Fast-flashing green	The line receives an incoming call.
Slow-flashing green	The call is placed on hold.
Off	The line is inactive.

**Line key LED** (configured as a BLF key or BLF List key)

LED Status	Description
Solid green	The monitored user is idle.
Fast-flashing red (200ms)	The monitored user receives an incoming call.
Solid red	The monitored user is busy. The monitored user's conversation is placed on hold (This LED status requires server support).
Slow-flashing red (1s)	The call is parked against the monitored user's phone number.
Off	The monitored user does not exist.

**Line key LED** (used as a page switch key)

LED Status	Description
Solid red	There is a parked call on the line key of the non-current page.
Fast-flashing green	The line receives an incoming call on the line key of the non-current page.
Fast-flashing red	The monitored user receives an incoming call on the line key of the non-current page.
Off	The line keys are idle.

**Line key LED** (associated with a shared line)

The local SCA phone indicates the phone is involved in an SCA call, while the monitoring SCA phone indicates the phone is not involved in the SCA call.

LED Status	Description
Off	The shared line is idle.
Fast-flashing green	The shared line receives an incoming call.
Solid green (for local SCA phone) Solid red (for monitoring SCA phone)	The shared line is in conversation. The shared line is dialing. The shared line is seized. The shared line conversation is barged in by the other shared line party.
Slow-flashing green (for local SCA phone) Slow-flashing red (for monitoring SCA phone)	The shared line conversation is placed on public hold.
Slow-flashing green (for local SCA phone) Solid red (for monitoring SCA phone)	The shared line conversation is placed on private hold. For a multi-party call, all the shared line parties participating in this call place the shared line conversation on hold.



**Line key LED** (associated with a bridged line)

The local BLA phone indicates the phone is involved in a BLA call, while the monitoring BLA phone indicates the phone is not involved in the BLA call.

LED Status	Description
Off	The bridged line is idle.
Fast-flashing green	The bridged line receives an incoming call.
Solid green (for local BLA phone) Solid red (for monitoring BLA phone)	The bridged line is in conversation. The bridged line is dialing. The bridged line is seized.
Slow-flashing green (for local BLA phone) Slow-flashing red (for monitoring BLA phone)	The bridged line conversation is placed on hold.

**Note**

The above introduces the default LED status. The statuses of the power indicator LED and BLF key LED are configurable via web user interface. You can also customize the BLF key LED status and BLF key behavior. For more information, contact your system administrator.

## User Interfaces

Two ways to customize configurations of your SIP-T46S IP phone:

- The user interface on the IP phone.
- The user interface in a web browser on your PC.

The hardware components keypad and LCD screen constitute the phone user interface, which allows the user to execute all call operation tasks and basic configuration changes directly on the phone. In addition, you can use the web user interface to access all configuration settings. In many cases, it is possible to use either the phone user interface and/or the web user interface interchangeably. However, in some cases, it is only possible to use one or the other interface to operate the phone and change settings.

## Phone User Interface

You can customize your phone by pressing the **Menu** soft key to access the phone user interface. The Advanced option is only accessible to the administrator, and the default administrator password is "admin" (case-sensitive). For more information on customizing your phone with the available options from the phone user interface, refer to [Customizing Your Phone](#) on page 39.

**Note** For a better understanding of the menu structure, please refer to [Appendix B - Menu Structure](#) on page 225.

## Web User Interface

In addition to the phone user interface, you can also customize your phone via web user interface. In order to access the web user interface, you need to know the IP address of your new phone. To obtain the IP address, press the OK key on the phone when the phone is idle. Enter the IP address (e.g., <http://192.168.0.10> or 192.168.0.10 for IPv4; [http://\[2005:1:1:1:215:65ff:fe64:6e0a\]](http://[2005:1:1:1:215:65ff:fe64:6e0a]) or [2005:1:1:1:215:65ff:fe64:6e0a] for IPv6) in the address bar of a web browser on your PC. The default administrator user name and password are both "admin" (case-sensitive).

**Note** The access to the Advanced settings of the Account or Network via web user interface may be blocked by the web browser (e.g., Chrome, Firebox) if you have installed "Adblock Plus plugin".

The options you can use to customize the IP phone via phone user interface and/or via web user interface are listed in the following table:

Options	Phone User Interface	Web User Interface
<b>Status</b>		
--IPv4		
--MAC		
--Firmware	√	√
--Network		
--Phone		
--Accounts		
<b>Basic Phone Settings</b>		
--Wallpaper	√	
--Screen Saver	√	√
--Power Saving	x	
--Backlight	√	
--Contrast	√	x
--Language	√	/

Options	Phone User Interface	Web User Interface
--Time & Date	√	
--Administrator Password	√	
--Key As Send	√	
--Phone Lock	√	
-- Audio Settings		
--Ring Tones	√	
--Key Tone	√	
--Contact Management		
--Directory	x	
--Local Directory	√	
--Blacklist	√	
--Remote Phone Book	x	
--Call History Management	√	
--Search Source List in Dialing	x	
--Headset Use	√	
--Bluetooth Headset	√	
--DSS Keys	√	
--Account Registration	√	
--Dial Plan	x	
--Emergency Number	x	
--Live Dialpad	x	
--Hotline	√	
<b>Basic Call Features</b>		
--Recent Call In Dialing	x	
--Auto Answer	√	
--Auto Redial	√	
--Call Completion	√	
-- ReCall	√	
--Do Not Disturb (DND)	√	
--Call Forward	√	√
--Call Transfer	√	
--Call Waiting	√	
--Conference	x	
--Call Park	√	
--Call Pickup	√	
--Anonymous Call	√	
--Anonymous Call Rejection	√	
<b>Advanced Phone Features</b>		
--Busy Lamp Field (BLF)	√	
--BLF List	x	√
--Call Recording	√	

Options	Phone User Interface	Web User Interface
--Hot Desking	✓	
--Intercom	✓	
--Multicast Paging	x	
--Music on Hold	x	
--Automatic Call Distribution (ACD)	x	
--Shared Call Appearance (SCA)	x	
--Bridged Lines Appearance (BLA)	x	
--Messages	✓	
<b>SIP Account</b>		
--User Options		
--Activation	✓	
--Label	✓	
--Display Name	✓	
--Register Name	✓	
--User Name	✓	
--Password	✓	✓
--Server Options		
--SIP Server 1/2	✓	
--Register Port	x	
--Outbound Status	✓	
--Outbound Proxy1/2	✓	
--Fallback Interval	✓	
--NAT Status	✓	

**Note** The table above lists most of the feature options. Please refer to the relevant sections for more information.

## Documentations

The following table shows documentations available for the SIP-T46S IP phone.

<b>Name</b>	<b>Contents</b>	<b>Where found</b>	<b>Language</b>
Quick Start Guide	Basic call features and phone customizations	In the package	English
		On the website	English/Chinese
User Guide	Phone/Web user interface settings, basic call features and advanced phone features	On the website	English/Chinese



## Getting Started

This chapter provides the following basic installation instructions and information for obtaining the best performance with the SIP-T46S IP phone. Topics include:

- [Packaging Contents](#)
- [Phone Installation](#)
- [Network Connection](#)
- [Phone Initialization](#)
- [Phone Status](#)
- [Basic Network Settings](#)
- [Wireless Network Settings](#)
- [Registration](#)
- [Idle Screen](#)
- [Entering Data and Editing Fields](#)

If you require additional information or assistance with your new phone, contact your system administrator.

## Packaging Contents

The following components are included in your SIP-T46S IP phone package:

- **SIP-T46S IP Phone**

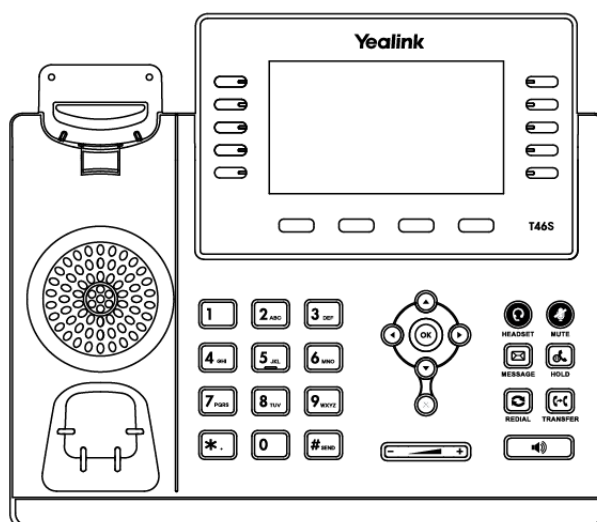

- **Phone Stand**

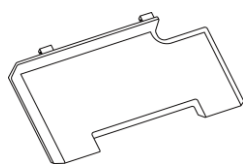

- **Handset & Handset Cord**

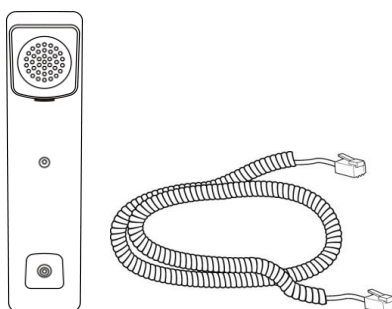

- **Ethernet Cable (2m CAT5E UTP cable)**

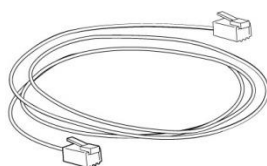

- **Quick Start Guide**

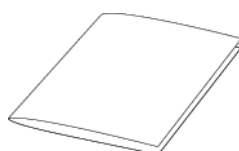

Check the list before installation. If you find anything missing, contact your system administrator.

## Optional Accessories

The following items are optional accessories for your SIP-T46S IP phone. You need to purchase them separately if required.



- **Power Adapter (5.5mm DC plug)**

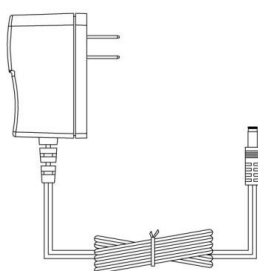

- **Wall Mount Bracket**

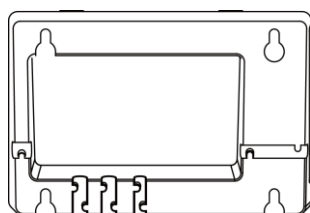

- **Headset YHS32/YHS33**



- **Wireless Headset Adapter EHS36**



- **Bluetooth USB Dongle BT40**

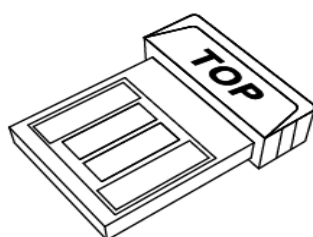

• **Wi-Fi USB Dongle WF40**



**Note**

We recommend that you use the accessories provided or approved by Yealink. The use of unapproved third-party accessories may result in reduced performance.

## Phone Installation

If your phone is already installed, proceed to [Phone Installation](#) on page 20.

This section introduces how to install the phone:

- 1) Attach the stand or the optional wall mount bracket
- 2) Connect the handset and optional headset
- 3) Connect the optional USB flash drive
- 4) Connect the power

1) **Attach the stand or the optional wall mount bracket**

**Desk Mount Method**

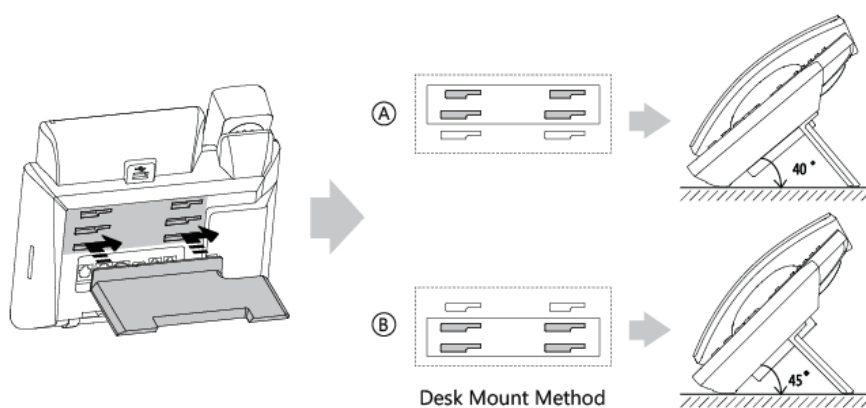

### Wall Mount Method (Optional)

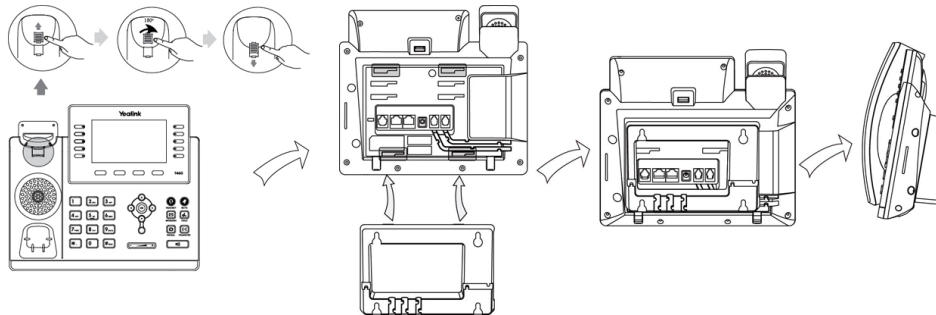

#### Note

The hookswitch tab has a lip which allows the handset to stay on-hook when the IP phone is mounted vertically.

For more information on how to attach the wall mount bracket, refer to [Yealink Wall Mount Quick Installation Guide for Yealink IP Phones](#).

### 2) Connect the handset and optional headset

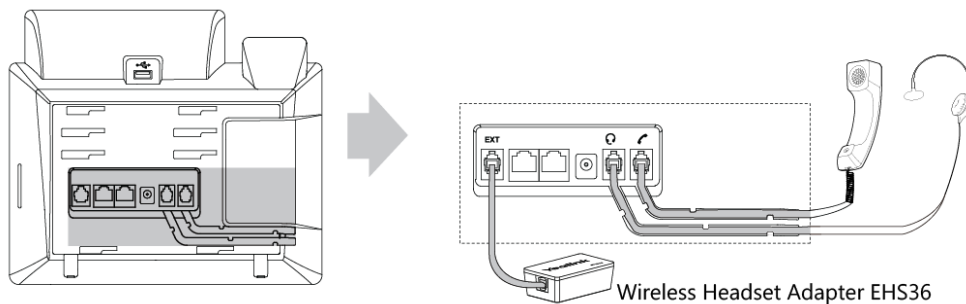

#### Note

The EXT port can also be used to connect an expansion module EXP40.

For more information on how to use EHS36 and EXP40, refer to [Yealink EHS36 User Guide](#) and [Yealink EXP40 User Guide](#).

### 3) Connect the optional USB flash drive

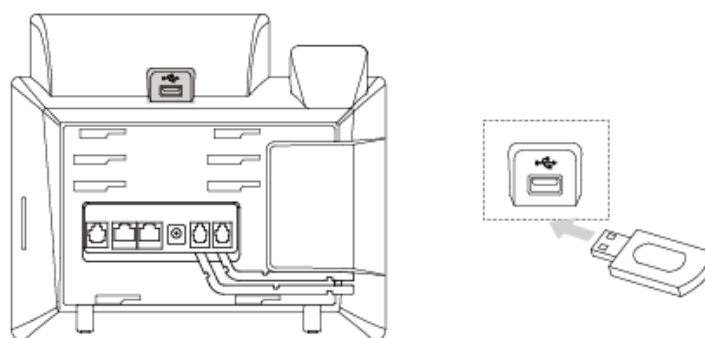

#### Note

The USB flash drive should be purchased separately if required.

The USB port can also be used to connect the Bluetooth USB dongle BT40 or Wi-Fi USB dongle WF40. The Bluetooth USB dongle BT40 and Wi-Fi USB dongle WF40 should be purchased separately. For more information on how to use the BT40 and WF40, refer to [Yealink Bluetooth USB Dongle BT40 User Guide](#) and [Yealink Wi-Fi USB Dongle WF40 User Guide](#).

### 4) Connect the power

You have two options for power connections. Your system administrator will advise you which one to use.

- AC power (Optional)
- Power over Ethernet (PoE)

#### AC Power (Optional)

##### To connect the AC power:

1. Connect the DC plug on the power adapter to the DC5V port on the phone and connect the other end of the power adapter into an electrical power outlet.

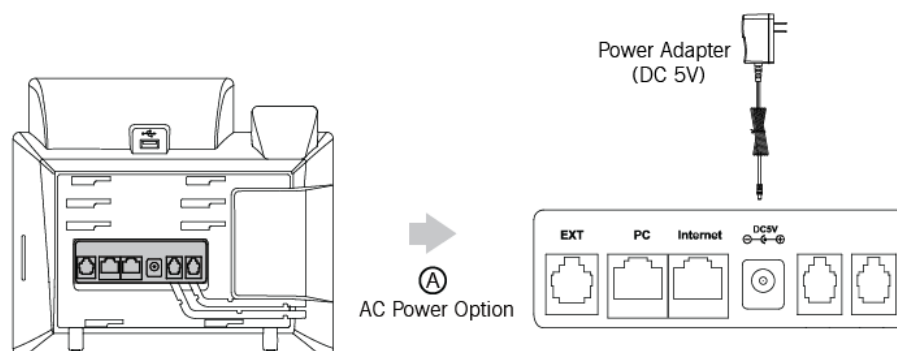

#### Note

The IP phone should be used with Yealink original power adapter (5V/2A) only. The use of the third-party power adapter may cause the damage to the phone.

## Power over Ethernet

With the included or a regular Ethernet cable, the SIP-T46S IP phone can be powered from a PoE-compliant switch or hub.

### To connect the PoE:

1. Connect the Ethernet cable between the Internet port on the phone and an available port on the in-line power switch/hub.

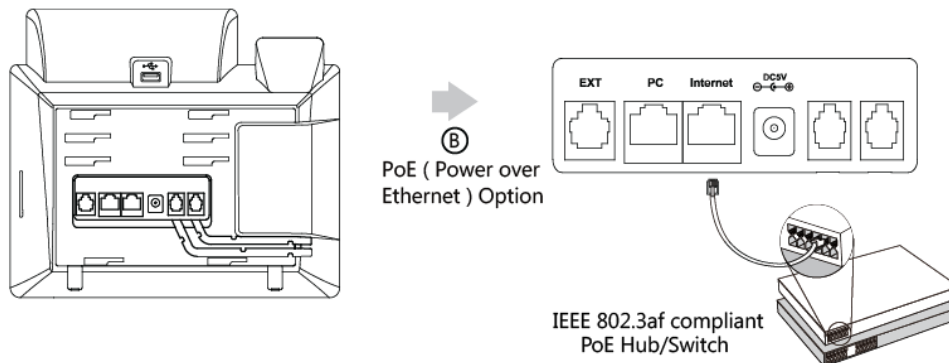

### Note

If in-line power is provided, you don't need to connect the phone to the power adapter. Make sure the switch/hub is PoE-compliant.

**Important!** Do not remove power from the phone while it is updating firmware and configurations.

## Network Connection

You have two options for network connection. You can select one of them according to the current office environment.

- Connecting to the wired network
- Connecting to the wireless network

## Connecting to the Wired Network

You can connect your phone to a wired network.

Before connecting your phone to the wired network, it is important to note that the Wi-Fi feature should be disabled. For more information, refer to [Connecting to the Wireless Network](#) on page 24.

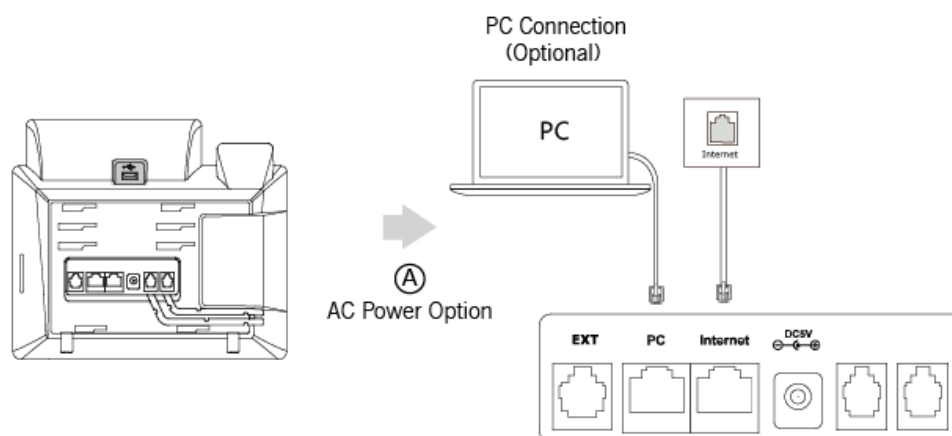

### Note

The phone can also share the network with another network device such as a PC (personal computer). This is an optional connection. We recommend that you use the Ethernet cable provided by Yealink. The PC port may be disabled, contact your system administrator for more information.

## Connecting to the Wireless Network

Yealink SIP-T46S IP phone supports Wi-Fi feature. You can connect your phone to a wireless network. The wireless network is more convenient and cost-effective than wired network. The PC port is unavailable when using wireless network. For more information on how to connect to a wireless network, refer to [Wireless Network Settings](#) on page 28.

## Phone Initialization

After your phone is powered on, the system boots up and performs the following steps:

### Automatic Phone Initialization

The phone finishes the initialization by loading the saved configuration. The LCD screen displays "Welcome Initializing...Please wait" during the initialization.

## DHCP (Dynamic Host Configuration Protocol)

The phone attempts to contact a DHCP server in your network to obtain valid IPv4 network settings (e.g., IP address, subnet mask, default gateway address and DNS address) by default.

### Note

If your network does not use DHCP, proceed to [Basic Network Settings](#) on page 26.



## Phone Status

You can view phone status via phone user interface or web user interface.

Available information of phone status includes:

- Network status (IPv4 status or IPv6 status, IP mode and MAC address).
  - IPv4 uses a 32-bit address.
  - IPv6 is an updated version of the current Internet Protocol to meet the increased demands for unique IP addresses, using a 128-bit address.
- Phone status (product name, hardware version, firmware version, product ID, MAC address and device certificate status).
- Account status (register status of SIP accounts).

### To view the phone status via phone user interface:

1. Press , or press **Menu->Status**.
2. Press  or  to scroll through the list and view the specific information.



### To view the phone status via web user interface:

1. Open a web browser on your computer.
2. Enter the IP address in the browser's address bar, and then press the **Enter** key.  
(e.g., "http://192.168.0.10" for IPv4 or "http://[2005:1:1:1:215:65ff:fe64:6e0a]" for IPv6).

3. Enter the user name (admin) and password (admin) in the login page.

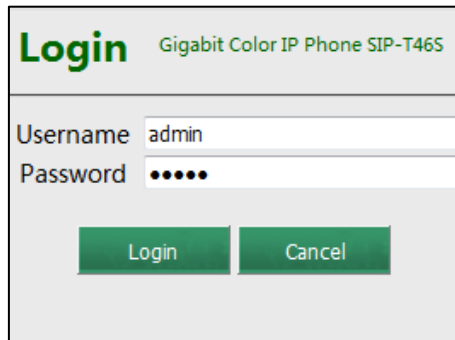

4. Click **Login** to login.

The phone status is displayed on the first page of the web user interface.

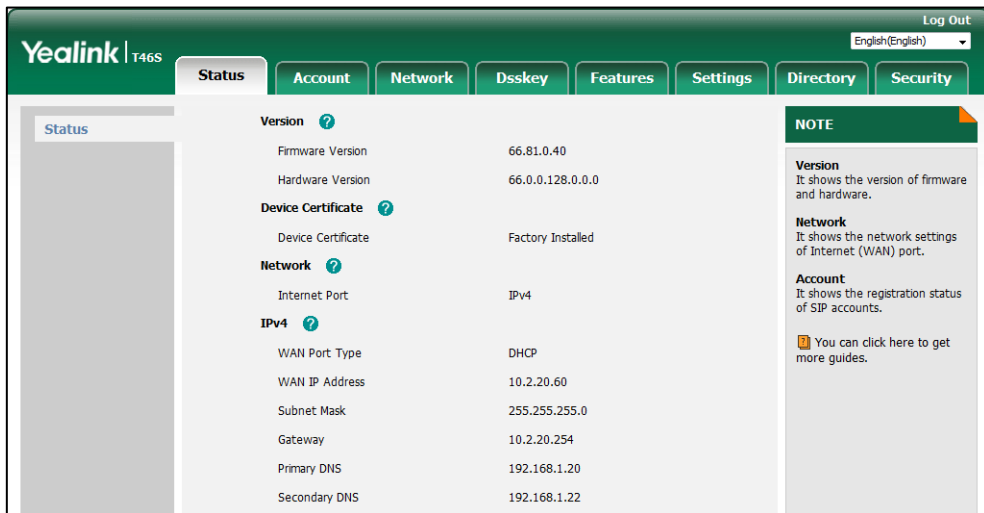

Version	
Firmware Version	66.81.0.40
Hardware Version	66.0.0.128.0.0.0

Device Certificate	
Device Certificate	Factory Installed

Network	
Internet Port	IPv4

IPv4	
WAN Port Type	DHCP
WAN IP Address	10.2.20.60
Subnet Mask	255.255.255.0
Gateway	10.2.20.254
Primary DNS	192.168.1.20
Secondary DNS	192.168.1.22

**NOTE**

**Version**  
It shows the version of firmware and hardware.

**Network**  
It shows the network settings of Internet (WAN) port.

**Account**  
It shows the registration status of SIP accounts.

You can click here to get more guides.

**Note**

If IP mode of the phone is configured as **IPv4 & IPv6**, you can enter either of them in the browser's address bar to view the phone status. IPv6 is not available on all servers. Contact your system administrator for more information.



## Basic Network Settings

If your phone cannot contact a DHCP server for any reason, you need to configure network settings manually. The IP phone can support either or both IPv4 and IPv6 addresses.

**To configure the IP mode via phone user interface:**

1. Press **Menu**->**Advanced** (default password: admin) ->**Network**->**WAN Port**.



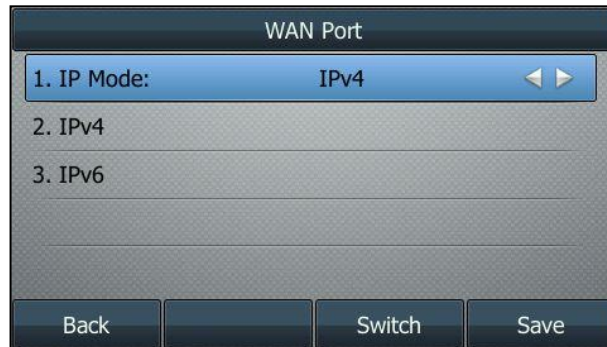

- Press  or , or the **Switch** soft key to select **IPv4**, **IPv6** or **IPv4 & IPv6** from the **IP Mode** field.





- Press the **Save** soft key to accept the change or the **Back** soft key to cancel.

You can configure a static IPv4 address for the IP phone. Before configuring it, make sure that the IP mode is configured as **IPv4** or **IPv4 & IPv6**.

**To configure a static IPv4 address via phone user interface:**

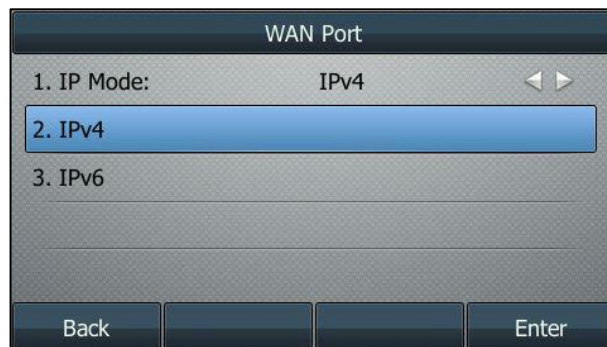
- Press **Menu->Advanced** (default password: admin) -> **Network->WAN Port**.
- Press  or  to select **IPv4** and then press the **Enter** soft key.



- Press  or , or the **Switch** soft key to select the **Static IP** from the **Type** field.
- Enter the desired value in the **IP Address**, **Subnet Mask**, **Default Gateway**, **Pri.DNS** and **Sec.DNS** field respectively.

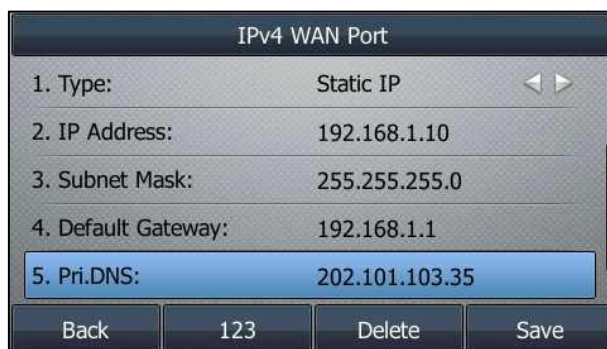



- Press the **Save** soft key to accept the change or the **Back** soft key to cancel.



You can configure a static IPv6 address for the IP phone. Before configuring it, make sure that

the IP mode is configured as **IPv6** or **IPv4 & IPv6**.

**To configure a static IPv6 address via phone user interface:**

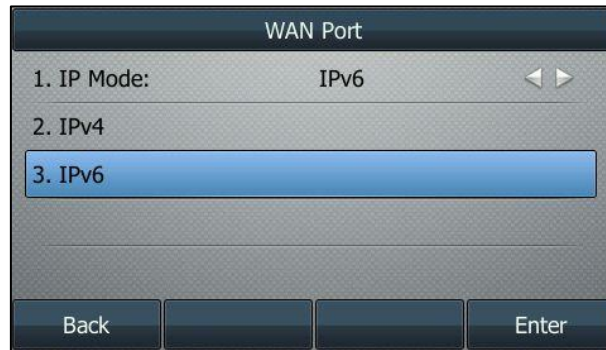
1. Press **Menu**->**Advanced** (default password: admin) ->**Network**->**WAN Port**
2. Press  or  to select **IPv6** and then press the **Enter** soft key.



3. Press  or , or the **Switch** soft key to select the **Static IP** from the **Type** field.
4. Enter the desired value in the **IP Address**, **IPv6 IP Prefix**, **Default Gateway**, **Pri.DNS** and **Sec.DNS** field respectively.

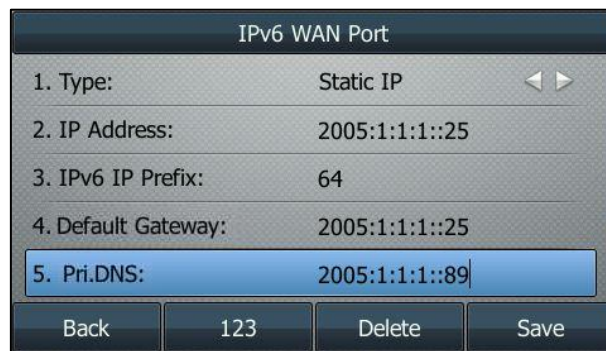

5. Press the **Save** soft key to accept the change or the **Back** soft key to cancel.

**Note** The wrong network settings may result in inaccessibility of your phone and may also have an impact on your network performance. For more information on these parameters, contact your system administrator.

## Wireless Network Settings

Wi-Fi is a popular wireless networking technology that uses radio waves to provide wireless high-speed Internet and network connections. You can activate/deactivate the Wi-Fi mode on the IP phone, and then connect your phone to the desired wireless network.

**Note** Ensure that the Wi-Fi USB Dongle WF40 is properly connected to the USB port at the back of the IP phone. For more information, refer to [Phone Installation](#) on page 20.

## Activating the Wi-Fi Mode

When Wi-Fi USB dongle WF40 is connected to the USB port at the back of the IP phone, the LCD screen will prompt "Wi-Fi adapter has been added, scanning the available wireless network right now?". You can press the **OK** soft key to activate Wi-Fi mode directly and scan Wi-Fi devices automatically.

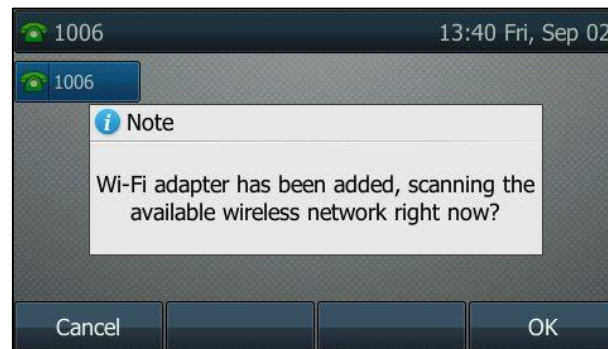

**To activate the Wi-Fi mode via phone user interface:**

1. Press **Menu**->**Basic**->**Wi-Fi**.
2. Press ◀ or ▶, or the **Switch** soft key to select **On** from the **Wi-Fi** field.
3. Press the **Save** soft key.

The IP phone scans the available wireless networks in your area.





## Connecting to the Wireless Network

Three ways to connect SIP-T46S IP phone to the wireless network:

- Manually connect to an available wireless network
- Wi-Fi Protected Setup (WPS)
- Manually add a wireless network

## Manually Connect to an Available Wireless Network

To manually connect to a wireless network via phone user interface:

1. Press **Menu**->**Basic**->**Wi-Fi**.
2. Press  or  to highlight **X Available Network(s)** (X represents the number of available networks), and then press the **Enter** soft key.

If there is no available wireless network, press the **Scan** soft key to search for the wireless network again.

3. Press  or  to select the desired wireless network.



4. Press the **Connect** soft key.
5. If the network is secure, enter its password in the **Password** field.



6. Press the **OK** soft key.
- Once the connection has completed successfully, the icon  appears after the name of the wireless network.



The Wi-Fi icon  appears on the status bar.



#### Note

For more information on the password of the wireless network, contact your system administrator.

## Wi-Fi Protected Setup (WPS)

Wi-Fi Protected Setup (WPS) provides simplified mechanisms to configure secure wireless networks. WPS can automatically configure a wireless network with a network name (SSID) and strong WPA data encryption and authentication.

Two methods supported by Yealink IP phones in the Wi-Fi protected setup:

- **Push Button Configuration (PBC):** The user simply has to press WPS key on both the IP phone and gateway/router to connect.
- **Personal Identification Number (PIN):** The user has to enter a PIN generated randomly by the IP phone on the gateway/router to connect.



### Push Button Configuration (PBC)

**To connect to the wireless network using PBC method:**

1. Press **Menu**->**Basic**->**Wi-Fi**.
2. Press the **WPS** soft key, and then select **WPS** from the prompt list.  
The LCD screen prompts "WPS has activated, connect within 120s."
3. Long press the WPS key on your gateway/router.  
Once WPS setup has completed successfully, the icon  appears after the name of wireless network.

### Personal Identification Number (PIN)

**To connect to the wireless network using PIN method:**

1. Press **Menu**->**Basic**->**Wi-Fi**.
2. Press  or , or the **Switch** soft key to select **On** from the **Wi-Fi** field.  
The IP phone scans the available wireless networks in your area.

3. Press the **WPS** soft key, and then select **WPS-PIN** from the prompt list.  
The LCD screen prompts "Please input below PIN code on your Wi-Fi router and press OK to start connecting: xxx".
4. Log into your gateway/router's web interface, and configure it to search the clients. For more information, refer to the documentation from the gateway/router manufacturer.  
Once WPS-PIN setup has completed successfully, the gateway/router's web interface will prompt success.



**Note**

Contact your gateway/router provider for more information.

## Manually Add a Wireless Network

If your gateway/router has SSID broadcast disabled, it might not appear in the scanning results. In that case, you must manually add a wireless network.



**To add a wireless network:**

1. Press **Menu->Basic->Wi-Fi**.
2. Press  or  to highlight **Known network**, and then press the **Add** soft key.
3. Use the WLAN settings obtained from your gateway/router to configure this WLAN Profile on the IP phone. Do the following:
  - a) If you select **None** or **WEP** from the pull-down list of **Security Mode**:  
Enter the profile name, SSID and WPA shared key in the corresponding fields.
  - b) If you select **WPA-PSK** or **WPA2-PSK** from the pull-down list of **Security Mode**:  
Select the desired Cipher type (**TKIP**, **AES** or **TKIP AES**) from the pull-down list of **Cipher Type**.  
Enter the profile name, SSID and WPA shared key in the corresponding fields.
4. Press the **Save** soft key to accept the change or the **Back** soft key to cancel.

The connected wireless networks will be saved to **Known network** list. The **Known network** list can store up to 5 wireless networks, you can specify the priority to connect to the corresponding wireless network.

## Viewing the Wireless Network Information

**To view the wireless network information via phone user interface:**

1. Press **Menu->Basic->Wi-Fi->X Available Network(s)** (X represents the number of available networks).
2. Press  or  to highlight the desired wireless network.
3. Press the **Detail** soft key to view the detailed wireless network information (e.g., Profile Name, SSID or Signal Strength).



If the IP phone is connected to a wireless network successfully, you can also press **Menu->Basic->Wi-Fi->Wireless Status** to view the connected wireless network information.



## Managing the Saved Wireless Network

Once the IP phone has ever been connected to a wireless network successfully, the wireless network profile will be saved in **Known network** list. The next time you enable Wi-Fi feature, the IP phone will be automatically connected to the wireless network which has the highest priority (the top one). Up to 5 wireless network profiles can be saved in **Known network** list. If you want to add a new one when the IP phone has already saved 5 wireless network profiles, please delete the older saved profile before adding.

**To manage the Known network via phone user interface:**

1. Press **Menu->Basic->Wi-Fi->Known network**.



2. Press the **Option** soft key.
3. Do one of the following:
  - To edit the wireless network profile:
    - 1) Select **Edit** from the prompt list.
    - 2) Edit the desired wireless network information.
    - 3) Press the **Save** soft key.
  - To change the priority of the wireless network:

- 1) Select **Move Up** or **Move Down** from the prompt list to improve or lower the priority of the wireless network that the IP phone automatically connects to.
- To delete the saved wireless network profile(s):
  - 1) Select **Delete** or **Delete All** from the prompt list.If you delete your wireless network profile from your phone, you need to manually connect to it next time.

## Disconnecting the Wireless Network Connection

### To disconnect wireless network via phone user interface:

1. Press **Menu->Basic->Wi-Fi->X Available Network(s)** (X represents the number of available networks)
2. Select the connected wireless network, and then press the **Disconnect** soft key.

The wireless network is disconnected. You can press the **Connect** soft key to connect again.

## Deactivating the Wi-Fi Mode

### To deactivate the Wi-Fi mode via phone user interface:

1. Press **Menu->Basic->Wi-Fi**.
2. Press  or , or the **Switch** soft key to select **Off** from the **Wi-Fi** field.



3. Press the **Save** soft key to accept the change.

The Wi-Fi icon  disappears from the status bar.

Wi-Fi is configurable via web user interface at the path **Network->Wi-Fi**.

## Registration

Generally, your phone will be deployed with multiple other phones. In this case, your system administrator will configure the phone parameters beforehand, so that after you start up your phone, the phone will be registered and ready for use. The SIP-T46S IP phone supports up to 16



accounts. If your phone is not registered, you may have to register it. For more information on how to register your phone, refer to [Account Management](#) on page 103.

## Idle Screen

If the phone has successfully started up, the idle LCD screen will be displayed as below.

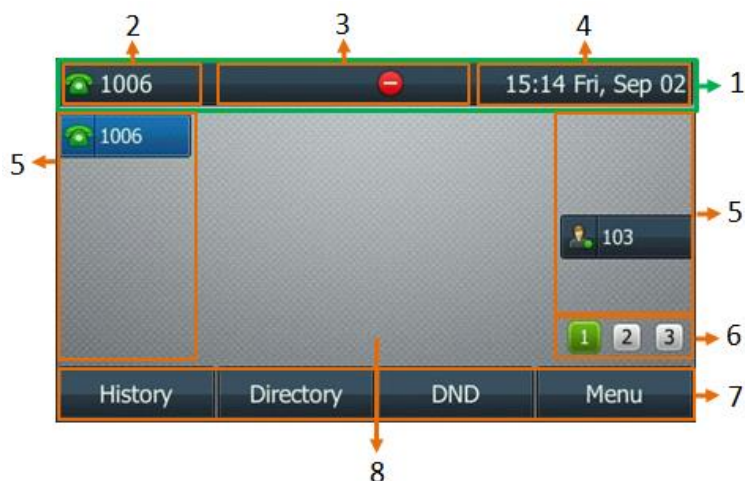

### Idle screen description:











No.	Name	Description
1	Status Bar	This area shows the phone's default account, icons and the time and date.
2	Default Account	The label of the default account is displayed on the left of the status bar. For more information, refer to <a href="#">Default Account</a> on page 104. <b>Note:</b> You can configure the IP phone not to display the default account. Contact your system administrator for more information.
3	Icons	Icons are displayed in the middle of the status bar. For more information, refer to <a href="#">Icon Instructions</a> on page 3.
4	Time and Date	The phone's time and date are displayed on the right of the status bar. For more information, refer to <a href="#">Time &amp; Date</a> on page 48.
5	Line Keys	This area shows the line key labels. You can customize the line key as other functions. For more information, refer to <a href="#">Line Keys</a> on page 89.
6	Page Icons	This area shows three page icons of line keys. For more information, refer to <a href="#">Page Tips</a> on page 91.
7	Soft Keys	This area shows the soft key labels. The default soft key labels are "History", "Directory", "DND" and "Menu".
8	Wallpaper	This area shows the wallpaper which can be customized. For more information, refer to <a href="#">Wallpaper</a> on page 39.

## Entering Data and Editing Fields

You can enter data and edit fields using the phone keypad.

Keypad on the phone provides different characters (or numbers) when using the **2aB**, **abc**, **Abc**, **ABC** or **123** input mode. You can change the following input modes to enter data and edit fields on your phone. When your phone keypad matches the input mode, you can press the keypad repeatedly to view the character (or number) options and stop to select. When the character (or number) you want to enter displays in the field, wait for one second, and enter the next character (or number).









The following table lists the input modes and character (or number) options for the keypad:





Input Mode Keypad	2aB	abc	Abc (initials in capitals)	ABC	123
	1				1
	2abcABC	abc2äæååå ääç	abc2äæååå ääç	ABC2ÄÆÅ ÅÄÅÇ	2
	3defDEF	def3èéëëë ëëëëë	def3èéëëë ëëëëë	DEF3ÈÉÊËË ËËËËË	3
	4ghiGHI	ghi4íîï	ghi4íîï	GHI4ÌÍÏ	4
	5jklJKL	jkl5£	jkl5£	JKL5£	5
	6mnoMNO	mno6öøðòó òõñ	mno6öøðòó òõñ	MNO6ÖØ ÒÓÕÑ	6
	7pqrsPQRS	pqrs7ßŠ	pqrs7ßŠ	PQRS7Š	7
	8tuvTUV	tuv8ùúûü	tuv8ùúûü	TUV8ÙÚÛ Ü	8
	9wxyzWXY Z	wxyz9ýþ	wxyz9ýþ	WXYZ9ÝÞ	9
	0	space	space	space	0
	*,?!\\-()@/: ;+&%=<> £ \$¥¤[]{}~ ^_`~\$# "	*,?!\\-()@/: ;+&%=<> £ \$¥¤[]{}~ ^_`~\$# "	*,?!\\-()@/: ;+&%=<> £ \$¥¤[]{}~ ^_`~\$# "	*,?!\\-()@/: ;+&%=<> £ \$¥¤[]{}~ ^_`~\$# "	*,!/[]

<b>Input Mode</b> <b>Keypad</b>	<b>2aB</b>	<b>abc</b>	<b>Abc</b> <b>(initials in capitals)</b>	<b>ABC</b>	<b>123</b>
	#	#	#	#	#

**To enter or edit data:**

Do one of the following:

<b>If you want to</b>	<b>Then you can</b>
Enter only digits (1), uppercase (A) characters, lowercase (a) characters, or alphanumeric (2aB) characters.	<p>Press a keypad key one or more times (depending on what input mode you're in) to enter the characters that is displayed on the keypad key.</p> <p>You can press the <b>abc</b> soft key one or more times to switch among uppercase (<b>ABC</b> soft key), numeric (<b>123</b> soft key), alphanumeric (<b>2aB</b> soft key), uppercase and lowercase (<b>Abc</b> soft key) and lowercase (<b>abc</b> soft key) input modes.</p> <p>For example, if the input mode is <b>ABC</b>:</p> <ul style="list-style-type: none"> <li>- To enter "A", press  once.</li> <li>- To enter "B", press  twice quickly.</li> <li>- To enter "C", press  three times quickly.</li> <li>- To enter "2ÄËÄÄÄÄÄÇ", press  more than three times quickly.</li> </ul> <p><b>Note:</b> When you are in the uppercase (<b>ABC</b> soft key), uppercase and lowercase (<b>Abc</b> soft key) or lowercase (<b>abc</b> soft key) input mode,  is not available.</p>
Enter special characters.	<p>Press the keypad key  or , or press .</p> <p><b>For  Key:</b></p> <ul style="list-style-type: none"> <li>- If it is in the uppercase (<b>ABC</b> soft key), uppercase and lowercase (<b>Abc</b> soft key) or lowercase (<b>abc</b> soft key) input mode, it will provide the space character.</li> <li>- If it is in the numeric (<b>123</b> soft key) or alphanumeric (<b>2aB</b> soft key) input mode, it will only provide the digit <b>0</b>.</li> <li>- If it is in the numeric (<b>123</b> soft key) or alphanumeric (<b>2aB</b> soft key) input mode, it will provide the special character + by long</li> </ul>

If you want to	Then you can
	<p>pressing about 2 seconds on the dialing/pre-dialing screen.</p> <p><b>For</b>  <b>key:</b></p> <ul style="list-style-type: none"> <li>- It only provides the pound character #.</li> </ul> <p><b>For</b>  <b>key:</b></p> <ul style="list-style-type: none"> <li>- If it is in the uppercase (<b>ABC</b> soft key), lowercase (<b>abc</b> soft key), uppercase and lowercase (<b>Abc</b> soft key) or alphanumeric (<b>2aB</b> soft key) input mode, it will provide the following special characters:  <code>*.,?!\\-()@/!:_;+&amp;%=&lt;&gt; £ \$ ¥ ¢ [] {} ~ ^ ¡ ¢ \$ # "  </code></li> <li>- If it is in the numeric (<b>123</b> soft key) input mode, it will provide the following special characters: <code>.*:/@[]</code>.</li> </ul>
Delete text you entered.	<p>Press  or  to position the cursor to the right of the text you want to delete, and then press the <b>Delete</b> soft key to delete one character at a time.</p>

## Customizing Your Phone

You can customize your SIP-T46S IP phone by personally configuring certain settings, for example, contrast, time & date and ring tones. You can add contacts to the phone's local directory manually or from call history. You can also personalize different ring tones for different callers.

This chapter provides basic operating instructions for customizing your phone. Topics include:

- [General Settings](#)
- [Audio Settings](#)
- [Contact Management](#)
- [Call History Management](#)
- [Search Source List in Dialing](#)
- [System Customizations](#)

If you require additional information or assistance with your new phone, contact your system administrator.

## General Settings

### Wallpaper

You can customize the wallpaper of the SIP-T46S IP phone, and can change the wallpaper image via phone user interface or web user interface. You can also upload custom pictures as wallpaper images via web user interface.

The SIP-T46S IP phone supports the file format of pictures in the following table:

Format	Resolution	File Size
*.jpg/*.png/*.bmp	≤1.8 megapixels	2MB of space should be reserved for the phone

**To upload the custom picture via web user interface:**

1. Click on **Settings->Preference**.
2. In the **Upload Wallpaper(480\*272)** field, click **Browse** to select the desired picture from your local system.

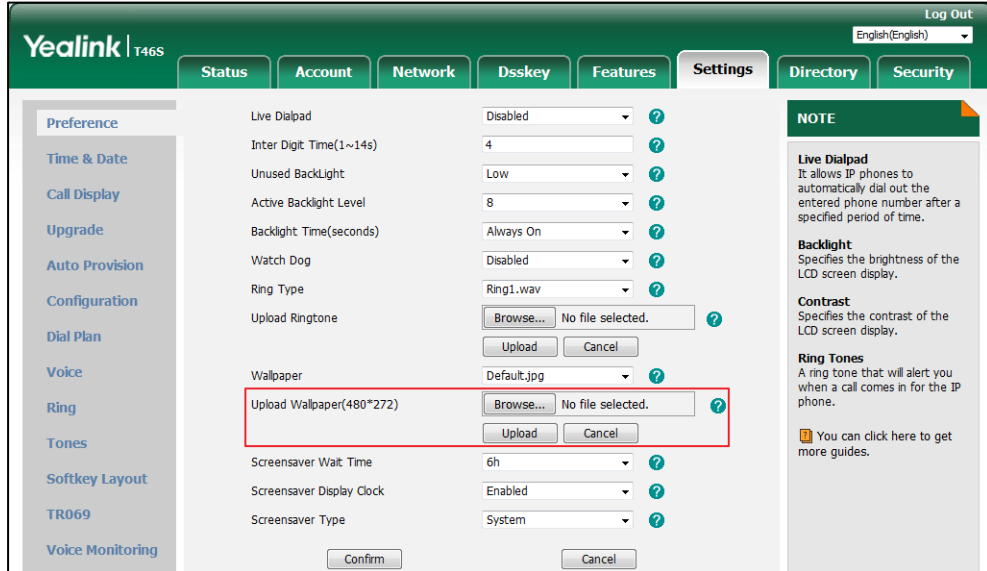

3. Click **Upload** to upload the file.

The custom picture appears in the pull-down list of **Wallpaper**.

You can only delete the custom wallpaper by clicking **Del** when selecting the desired custom wallpaper in the **Wallpaper** field.

**Note**

The SIP-T46S IP phone screen size is 4.3 inches (Resolution: 480x272). If the size of the custom wallpaper doesn't meet the IP phone screen size, the wallpaper will be stretched or zoomed out according to the IP phone screen size.

**To change the wallpaper via phone user interface:**

1. Press **Menu->Basic->Display->Wallpaper**.
2. Press **◀** or **▶**, or the **Switch** soft key to select the desired wallpaper image.



3. Press the **Save** soft key to accept the change or the **Back** soft key to cancel.

Wallpaper is configurable via web user interface at the path **Settings->Preference**.

## Screen Saver

The screen saver will automatically start when the IP phone is idle for the preset waiting time. The screen saver is used to blank the screen or fill it with moving images or patterns.

**The screen saver will be stopped if one of the following phone events occurs:**

- Press any key.
- Pick up/hang up the handset.
- There is an incoming call.
- A new prompt (e.g., missed call, new voice mail or forwarded call).
- The status of BLF key changes.

If your phone is idle again for a specified period of time, the screen saver will start again. The time & date and certain feature status icons (e.g., a new text message, auto answer, DND) will also display on the screen saver. For more information on the icons, refer to [Icon Instructions](#) on page 3. You can configure the phone whether to display the time & date on the screen saver or not.

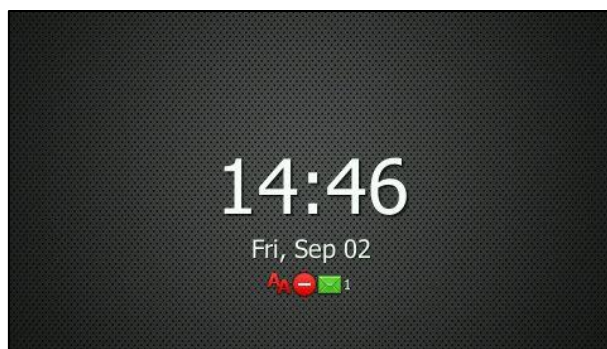

You can configure the screen saver of SIP-T46S IP phone, and upload custom pictures to set up a screen saver of your picture via web user interface. You can configure the screen saver wait time, screen saver type and screen saver display clock via phone user interface or web user interface.

The SIP-T46S IP phone supports the file format of custom pictures in the following table:

Format	Resolution	File Size
*.jpg/*.png/*.bmp	≤1.8 megapixels	2MB of space should be reserved for the phone

## Uploading the Custom Picture

To upload a custom picture via web user interface:

1. Click on **Settings->Preference**.
2. Select **Custom** from the pull-down list of **Screensaver Type**.
3. In the **Upload Screensaver** field, click **Browse** to locate the custom picture from your local system, and then click **Upload**.

This field appears only if **Screensaver Type** is set to **Custom**.

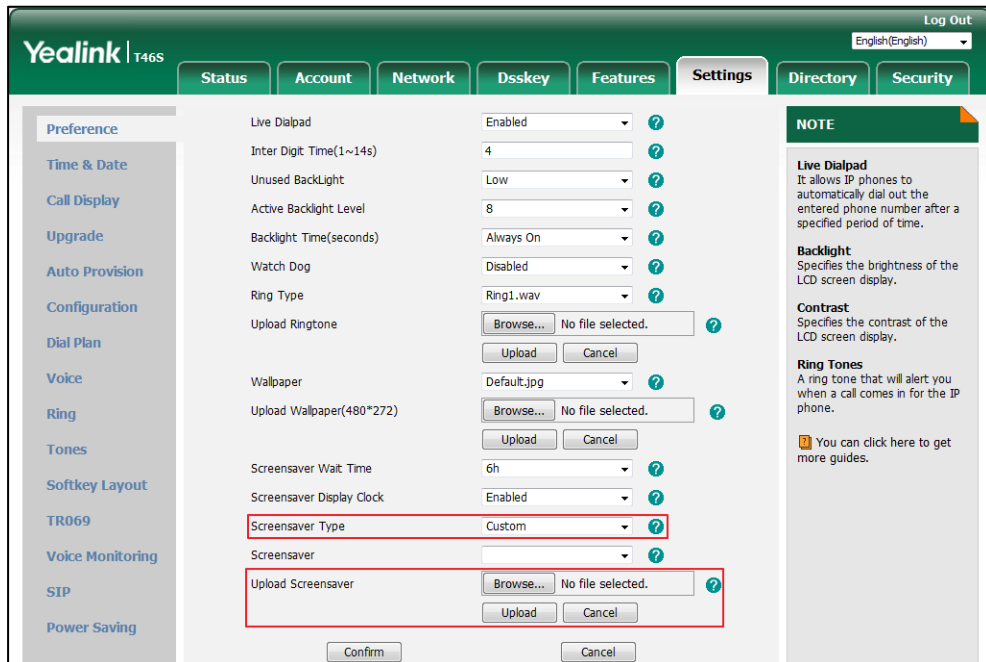

The custom picture appears in **Screensaver** list. You can only delete the custom picture by clicking **Del** when the desired custom picture is selected in the **Screensaver** field.

**Note** You can only upload one custom image at a time via web user interface.

## Configuring the Screen Saver

To configure the screen saver via phone user interface:

1. Press **Menu->Basic->Display->Screensaver**.
2. Press **◀** or **▶**, or the **Switch** soft key to select the desired wait time from the **Wait Time** field.
3. Press **◀** or **▶**, or the **Switch** soft key to select the desired value from the **Display Clock** field.
4. Press **◀** or **▶**, or the **Switch** soft key to select the desired screen saver type from the **Screensaver Type** field.

This field is configurable only if you have uploaded a custom picture via web user interface.

- If you select **System**.



The IP phone will automatically set the built-in picture as the screen saver.

- If you select **Custom**.

The IP phone will automatically set the custom pictures you upload as the screen saver, and display these pictures alternately.



5. Press the **Save** soft key to accept the change or the **Back** soft key to cancel.

Screen saver is configurable via web user interface at the path **Settings->Preference**.

## Power Saving

The power saving feature is used to turn off the backlight and screen to conserve energy. The IP phone enters power-saving mode after it has been idle for a certain period of time.

**The IP phone will exit power-saving mode if one of the following phone events occurs:**

- Press any key.
- Pick up/hang up the handset.
- There is an incoming call.
- A new prompt (e.g., missed call, new voice mail or forwarded call).
- The status of BLF key changes.

If the screen saver is enabled on your phone, power-saving mode will still occur.

You can configure the following power-saving settings:

- Office Hour
- Idle Timeout (minutes)

The office hour and idle timeout (minutes) settings work only if the power saving feature is enabled.

### Note

Power saving is configurable via web user interface only.

## Enabling the Power Saving

To enable the power saving feature via web user interface:

1. Click on **Settings->Power Saving**.
2. Select **Enabled** from the pull-down list of **Power Saving**.

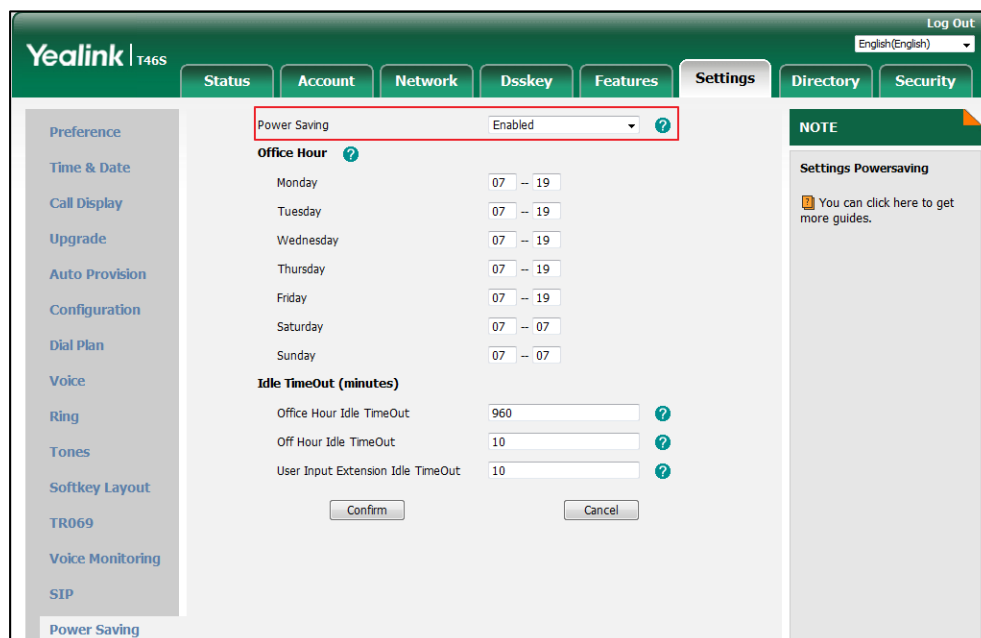

3. Click **Confirm** to accept the change.

## Configuring the Office Hour

Office Hour specifies the starting time and ending time in the office each day.

To configure the office hour via web user interface:

1. Click on **Settings->Power Saving**.

- Enter the starting time and ending time respectively in the desired day field.

The screenshot shows the Yealink T46S web interface. The 'Settings' tab is active, and the 'Power Saving' section is expanded. The 'Office Hour' section is highlighted with a red box, showing a table of days and times. Below it are input fields for 'Idle TimeOut (minutes)' for Office Hour, Off Hour, and User Input Extension. A 'Confirm' button is visible at the bottom of the form.

Day	Start Time	End Time
Monday	07	19
Tuesday	07	19
Wednesday	07	19
Thursday	07	19
Friday	07	19
Saturday	07	07
Sunday	07	07

Idle TimeOut (minutes)

Office Hour Idle TimeOut: 960

Off Hour Idle TimeOut: 10

User Input Extension Idle TimeOut: 10

Buttons: Confirm, Cancel

- Click **Confirm** to accept the change.

## Configuring the Idle Timeout

Idle Timeout specifies the period of time before the IP phone enters power-saving mode. The following three types of idle timeout you can configure:

- Office Hours Idle TimeOut:** Configures the idle timeout for office hours.
- Off Hours Idle TimeOut:** Configures the idle timeout for non-office hours.
- User Input Extension Idle TimeOut:** Configures idle timeout that applies after you use the IP phone (for example, press a key on the phone or pick up/hang up the handset).

By default, the Office Hours Idle Timeout is much longer than the Off Hours Idle Timeout. If you use the IP phone, the idle timeout that applies (User Input Extension Idle TimeOut or Office Hours/Off Hours Idle TimeOut) is the timeout with the highest value. If the phone has an incoming call or new message, the User Input Extension Idle TimeOut is ignored.

### To configure the idle timeout via web user interface:

- Click on **Settings->Power Saving**.
- Enter the desired value in the **Office Hours Idle TimeOut** field.  
The default value is 960, you can set to 1-960.
- Enter the desired value in the **Off Hours Idle TimeOut** field.  
The default value is 10, you can set to 1-10.
- Enter the desired value in the **User Input Extension Idle TimeOut** field.

The default value is 10, you can set to 1-30.

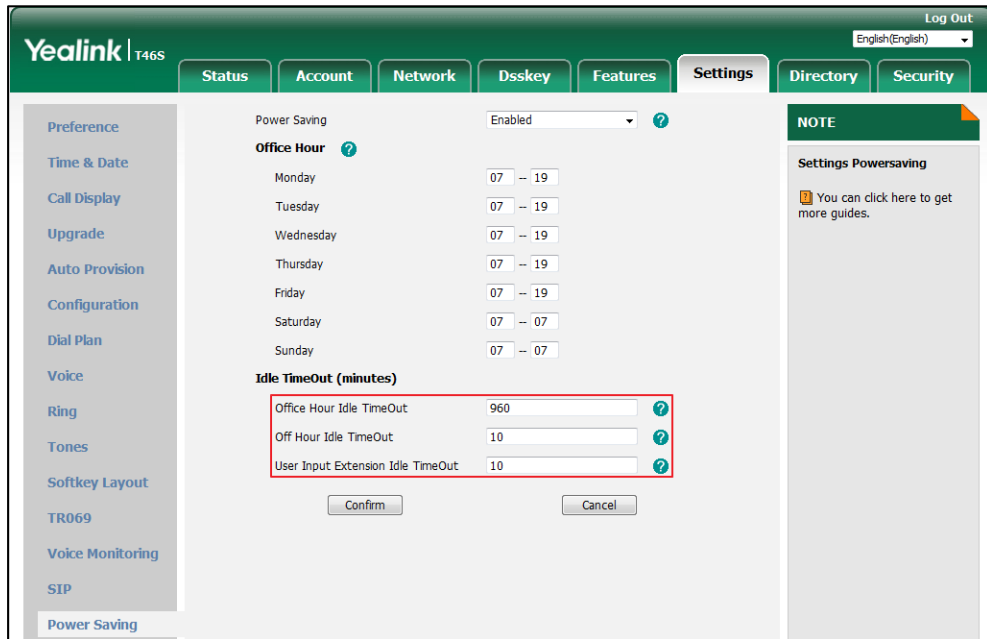

5. Click **Confirm** to accept the change.

## Backlight

Backlight has three options:

**Active Level:** The intensity of the LCD screen when the phone is active. You can change the intensity of the LCD screen. Digits (1-10) represent different intensities. 10 is the highest intensity.

**Inactive Level:** The intensity of the LCD screen when the phone is inactive. You can select a low intensity or turn off the backlight.

**Backlight Time:** The delay time to change the intensity of the LCD screen when the phone is inactive. You can select a desired time to change the intensity or turn on the backlight permanently.

- **Always On:** Backlight is on permanently.
- **15s, 30s, 1min, 2min, 5min, 10min or 30min:** Backlight is changed when the phone is inactive after the designated time (in seconds).

You can also change the intensity of the LCD screen of EXP40 connected to the SIP-T46S IP phone.

### To configure the backlight via phone user interface:

1. Press **Menu->Basic->Display->Backlight**.
2. Press **◀** or **▶** , or the **Switch** soft key to select the desired value from the **Active Level** field.
3. Press **◀** or **▶** , or the **Switch** soft key to select the desired value from the **Inactive**

**Level** field.

4. Press ◀ or ▶, or the **Switch** soft key to select the desired time from the **Backlight Time** field.



5. Press the **Save** soft key to accept the change or the **Back** soft key to cancel.

Backlight is configurable via web user interface at the path **Settings->Preference**.

## Contrast

You can only configure the contrast of the expansion module EXP40 connected to the SIP-T46S IP phone to a comfortable level on the phone. Ensure that the expansion module has been connected to the phone before configuration. The intensity of contrast ranges from 1 to 10 and the highest intensity is 10.

**To configure the contrast via phone user interface:**

1. Press **Menu->Basic->Display->Contrast**.

If EXP40 is not connected to the phone, the Contrast screen displays "No EXP".

2. Press ◀ or ▶, or the **Switch** soft key to increase or decrease the intensity of contrast.

The default contrast level is "6".





3. Press the **Save** soft key to accept the change or the **Back** soft key to cancel.

## Language

The default language of the phone user interface is English. If the language of your web browser

is not supported by the phone, the web user interface will use English by default. You can change the language for the phone user interface and the web user interface respectively.

**To change the language for the phone user interface directly:**

1. Press **Menu->Basic->Language**.
2. Press  or  to select the desired language.



3. Press the **Save** soft key to accept the change.  
Text displayed on the phone user interface will change to the selected language.

**To change the language for the web user interface:**

1. Select the desired language from the pull-down list at the top-right corner of web user interface.

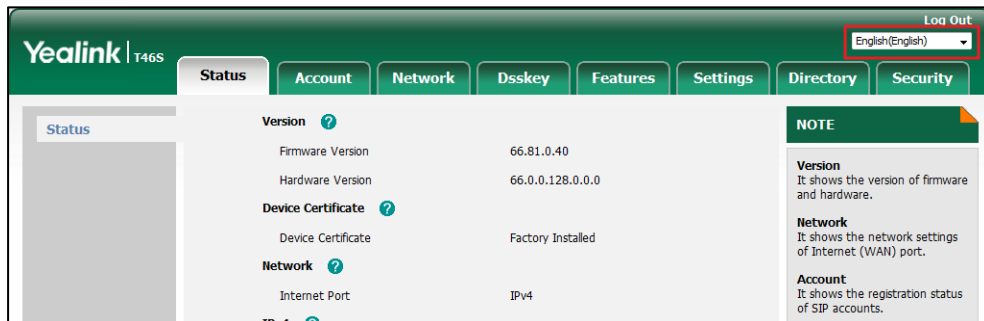



Text displayed on the web user interface will change to the selected language.

## Time & Date

The time and date are displayed on the LCD screen when the phone is idle. You can configure the phone to obtain the time and date from the SNTP server automatically, or configure the time and date manually. If the phone cannot obtain the time and date from the Simple Network Time Protocol (SNTP) server, contact your system administrator for more information.

**To configure the SNTP settings via phone user interface:**

1. Press **Menu->Basic->Time & Date->General->SNTP Settings**.
2. Press  or , or the **Switch** soft key to select the time zone that applies to your area

from the **Time Zone** field.

The default time zone is "+8".

3. Enter the domain name or IP address of SNTP server in the **NTP Server1** and **NTP Server2** field respectively.
4. Press ◀ or ▶, or the **Switch** soft key to select the desired value from the **Daylight Saving** field.
5. Press ◀ or ▶, or the **Switch** soft key to select the desired time zone name from the **Location** field.

This field appears only if **Daylight Saving** field is selected to **Automatic**.

The default time zone name is "China(Beijing)".



6. Press the **Save** soft key to accept the change or the **Back** soft key to cancel.

**Note**

Please refer to [Appendix A - Time Zones](#) for the list of available time zones on the IP phone.

**To configure the time and date manually via phone user interface:**

1. Press **Menu->Basic->Time & Date->General->Manual Settings**.
2. Enter the specific date and time.



3. Press the **Save** soft key to accept the change.  
The time and date displayed on the LCD screen will change accordingly.

**To configure the time and date format via phone user interface:**

1. Press **Menu->Basic->Time & Date->Time & Date Format**.

2. Press ◀ or ▶, or the **Switch** soft key to select the desired date format from the **Date Format** field.
3. Press ◀ or ▶, or the **Switch** soft key to select the desired time format (**12 Hour** or **24 Hour**) from the **Time Format** field.



4. Press the **Save** soft key to accept the change or the **Back** soft key to cancel.

There are 7 available date formats. For example, for the date format “WWW DD MMM”, “WWW” represents the abbreviation of the weekday, “DD” represents the two-digit day, and “MMM” represents the first three letters of the month.

The date formats available:

Date Format	Example (2016-09-02)
WWW MMM DD	Fri, Sep 02
DD-MMM-YY	02-Sep-16
YYYY-MM-DD	2016-09-02
DD/MM/YYYY	02/09/2016
MM/DD/YY	09/02/16
DD MMM YYYY	02 Sep, 2016
WWW DD MMM	Fri, 02 Sep

Time and date are configurable via web user interface at the path **Settings->Time & Date**.

**Note** You can also customize the date format. Contact your system administrator for more information.

## Administrator Password

The Advanced Settings option is only accessible to the administrator. The default administrator password is “admin”. For security reasons, you should change the default administrator password as soon as possible.



**To change the administrator password via phone user interface:**

1. Press **Menu**->**Advanced** (default password: admin) ->**Change Password**.
2. Enter the old password in the **Old PWD** field.
3. Enter the new password in the **New PWD** field.
4. Re-enter the new password in the **Confirm PWD** field.

5. Press the **Save** soft key to accept the change or the **Back** soft key to cancel.

Administrator password is configurable via web user interface at the path **Security**->**Password**.

## Key As Send

You can set the “#” key or “\*” key to perform as a send key while dialing.

**To configure key as send via phone user interface:**

1. Press **Menu**->**Features**->**Others**->**General**.
2. Press ◀ or ▶, or the **Switch** soft key to select # or \* from the **Key As Send** field, or select **Disabled** to disable this feature.

3. Press the **Save** soft key to accept the change or the **Back** soft key to cancel.

Key as send is configurable via web user interface at the path **Features**->**General Information**.

## Phone Lock

You can lock your phone temporarily when you are not using it. This feature helps to protect your phone from unauthorized use.





Phone lock consists of the following:

- Menu Key:** The **Menu** soft key is locked. You cannot access the menu of the phone until unlocked.
- Function Keys:** The function keys are locked. You cannot use the MESSAGE, REDIAL, HOLD, MUTE, TRANSFER, OK, X, navigation keys and soft keys until unlocked.
- All Keys:** All keys are locked except the Volume key, digit keys, # key, \* key, HEADSET key and Speakerphone key. You are only allowed to dial emergency numbers, reject incoming calls by pressing the X key or **Reject** soft key, answer incoming calls by lifting the handset, pressing the Speakerphone key, the HEADSET key, the OK key or **Answer** soft key, and end the call by hanging up the handset, pressing the Speakerphone key, **End Call** soft key or X key.

### Note

The emergency number setting, if desired, must be made before lock activation. For more information, refer to [Emergency Number](#) on page 112.

### To activate the phone lock via phone user interface:

1. Press **Menu**->**Basic**->**Phone Lock**.
2. Enter the desired PIN (default PIN: 123) in the **Unlock PIN** field, and then press the **OK** soft key.
3. Press  or , or the **Switch** soft key to select **Enabled** from the **Lock Enable** field.
4. Press  or , or the **Switch** soft key to select the desired type from the **Lock Type** field.
5. Enter the desired interval of automatic phone lock in the **Lock Time Out** field.

The default timeout is 0. It means the phone will not be automatically locked. You need to long press  to lock it immediately when the phone is idle.

If it is set to other values except 0 (e.g., 5), the phone will be locked when the phone is inactive in idle screen for the designated time (in seconds).



6. Press the **Save** soft key to accept the change.

When the phone is locked, the LCD screen prompts "Phone locked." and displays the icon .

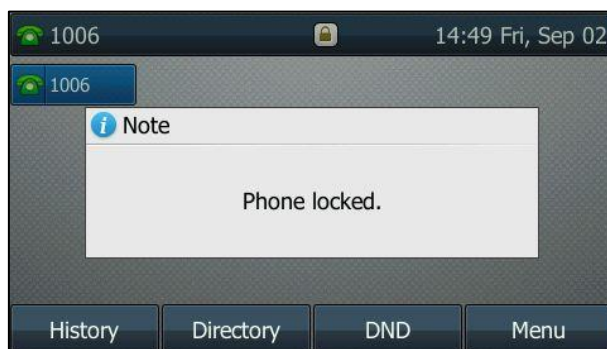

**To change the phone unlock PIN via phone user interface:**

1. Press **Menu->Basic->Change PIN**.
2. Enter the desired value in the **Old PIN**, **New PIN** and **Confirm PIN** field respectively.





3. Press the **Save** soft key to accept the setting or the **Back** soft key to cancel.

**Note** The unlock PIN length must be within 15 digits.

**To unlock the phone via phone user interface:**

1. Press any locked key, the LCD screen prompts "Unlock PIN".
2. Enter the desired PIN in the **Unlock PIN** field.





3. Press the **OK** soft key to unlock the phone.  
The icon  disappears from the LCD screen.  
You can long press  or wait for a period of time (if configured) to lock the phone again.

**Note**

You can also unlock the phone by administrator password. When you enter the administrator password to unlock the phone, the phone will turn to the Change PIN screen.

**To deactivate the phone lock via phone user interface:**

1. Press **Menu->Basic->Phone Lock**.
2. Enter the desired PIN (default PIN: 123) in the **Unlock PIN** field, and then press the **OK** soft key.
3. Press  or , or the **Switch** soft key to select **Disabled** from the **Lock Enable** field.



4. Press the **Save** soft key to accept the change.

Phone lock is configurable via web user interface at the path **Features->Phone Lock**.

## Audio Settings

### Volume

You can press the Volume key to adjust the ringer volume when the phone is idle or ringing. You can also press the Volume key to adjust the receiver volume of currently engaged audio devices (handset, speakerphone or headset) when the phone is in use.

#### To adjust the ringer volume when the phone is idle:

1. Press  to adjust the ringer volume.



#### To adjust the ringer volume when the phone is ringing:

1. Press  to adjust the ringer volume.

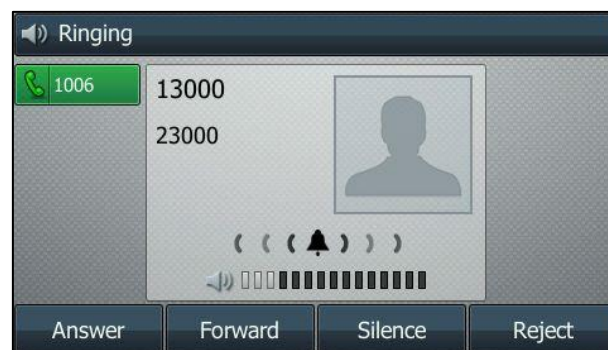

You can also press  to adjust the ringer volume when selecting a ring tone. For more information, refer to [Ring Tones](#) on page 56.

#### Note

If ringer volume is adjusted to minimum, the icon  will appear on the LCD screen.

**To adjust the volume when the phone is during a call:**

1. Press  to adjust the volume of currently engaged audio device (handset, speakerphone or headset).





You can also press  to adjust the volume when playing back the recording calls. For more information, refer to [Playing Back Recorded Calls](#) on page 174.

## Ring Tones

Ring tones are used to indicate incoming calls. You can select different ring tones to distinguish different accounts registered on your phone, or to distinguish your phone from your neighbor's.

**To select a ring tone for the phone via phone user interface:**



1. Press **Menu->Basic->Sound->Ring Tones->Common**.
2. Press  or  to select the desired ring tone.





3. (Optional.) Press  to adjust the ringer volume.
4. Press the **Save** soft key to accept the change or the **Back** soft key to cancel.

A ring tone for the phone is configurable via web user interface at the path **Settings->Preference->Ring Type**.

**To select a ring tone for the account via phone user interface:**

1. Press **Menu->Basic->Sound->Ring Tones**.
2. Press  or  to select the desired account and then press the **Enter** soft key.



3. Press  or  to select the desired ring tone.  
If **Common** is selected, this account will use the ring tone selected for the phone.



4. (Optional.) Press  to adjust the ringer volume.
5. Press the **Save** soft key to accept the change or the **Back** soft key to cancel.

A ring tone for the account is configurable via web user interface at the path **Account->Basic->Ring Type**.



**To upload a custom ring tone for your phone via web user interface:**

1. Click on **Settings->Preference**.
2. In the **Upload Ringtone** field, click **Browse** to locate a ring tone (the file format must be \*.wav) file from your local system.

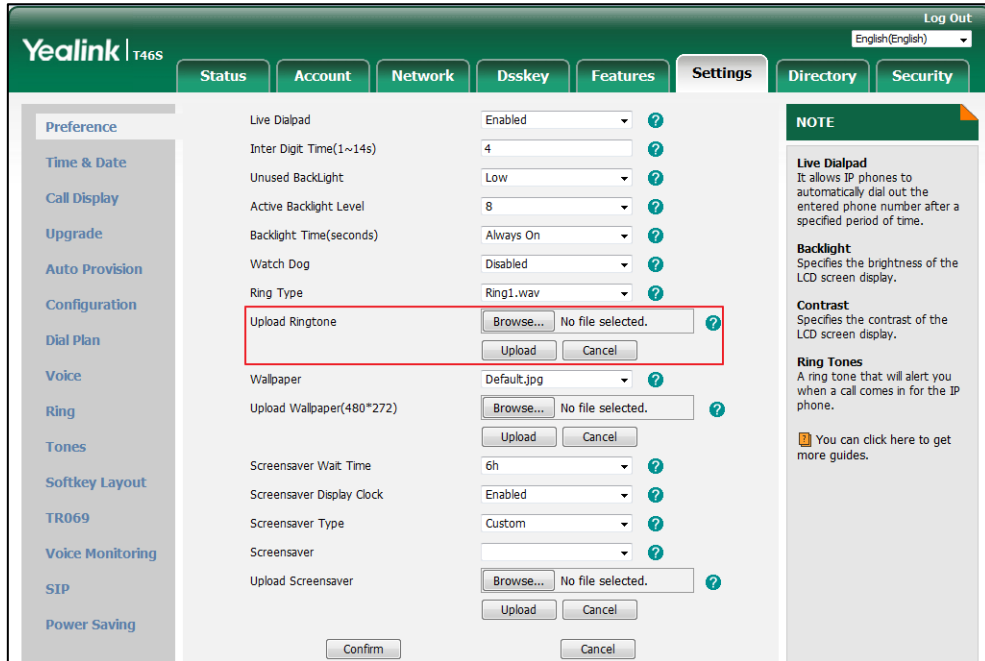

3. Click **Upload** to upload the file.

The custom ring tone appears in the pull-down list of **Ring Type**.

You can only delete the custom ring tone by clicking **Del** when selecting the desired custom ring tone in the **Ring Type** field.

**Note**

The priority of ring tone for an incoming call on the phone is as follows:  
 Contact ring tone (refer to [Adding Contacts](#)) > Group ring tone (refer to [Adding Groups](#)) > Account ring tone > Phone ring tone.

Single custom ring tone file must be within 8MB and total custom ring tone files must be within 20MB.



Uploading custom ring tones for your phone is configurable via web user interface only.

## Key Tone

If you enable key tone, the phone will produce a sound when you press the keypad.



**To configure key tone via phone user interface:**

1. Press **Menu**->**Basic**->**Sound**->**Key Tone**.
2. Press  or , or the **Switch** soft key to select **Enabled** or **Disabled** from the **Key Tone** field.



3. Press the **Save** soft key to accept the change or the **Back** soft key to cancel.

Key tone is configurable via web user interface at the path **Features**->**Audio**.

## Contact Management

This section provides the operating instructions for managing contacts. Topics include:

- [Directory](#)
- [Local Directory](#)
- [Blacklist](#)
- [Remote Phone Book](#)

### Directory

Directory provides easy access to frequently used lists. The lists may contain Local Directory, History, Remote Phone Book and LDAP. You can configure the list(s) to access for the **Directory** soft key.

#### Note



LDAP is disabled by default. For more information, contact your system administrator.

**To configure the list(s) to access for the Directory soft key via web user interface:**

1. Click on **Directory**->**Setting**.
2. In the **Directory** block, select the desired list from the **Disabled** column and then click .

The selected list appears in the **Enabled** column.

3. Repeat the step 2 to add more lists to the **Enabled** column.

4. To remove a list from the **Enabled** column, select the desired list and then click  .
5. To adjust the display order of enabled lists, select the desired list and then click  or  .

The LCD screen will display the list(s) in the adjusted order.

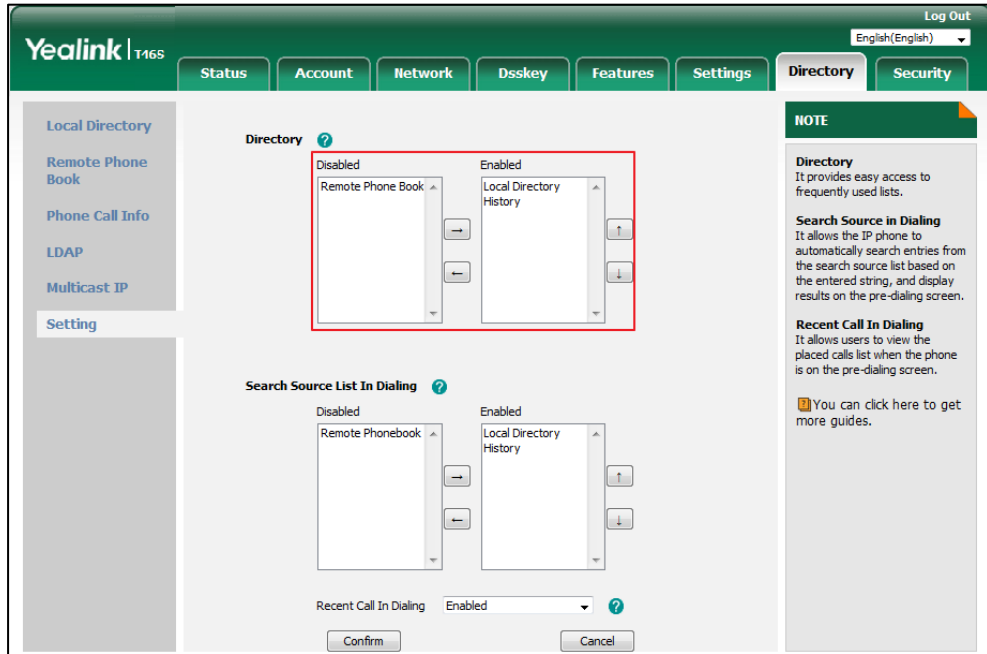

6. Click **Confirm** to accept the change.

**Note**

The list(s) to access for the **Directory** soft key is configurable via web user interface only.

**To view the directory list(s) via phone user interface:**

1. Press the **Directory** soft key when the phone is idle.  
The LCD screen displays the enabled list(s) in the directory.



If there is only one list in the directory, press the **Directory** soft key to enter this list directly.

**Note**

If the remote phone book and LDAP are not configured in advance, you cannot see remote phone book and LDAP lists on the phone user interface. For more information on remote phone book, refer to [Remote Phone Book](#) on page 76. For more information on LDAP, contact your system administrator.

## Local Directory

The built-in phone directory can store the names and phone numbers of your contacts. You can store up to 1000 contacts and 48 groups in your phone's local directory. You can add new groups and contacts, edit, delete or search for a contact, or simply dial a contact number from the local directory.

**Note** Local directory can be backed up on the provisioning server. For more information, contact your system administrator.

## Adding Groups



**To add a group to the local directory:**

1. Press the **Directory** soft key.

The IP phone enters the local directory directly as there is only Local Directory enabled in the directory by default.



If Local Directory is removed from the directory (refer to [Directory](#) on page 59), press **Menu->Directory->Local Directory** to enter the local directory.

2. Press the **AddGroup** soft key.
3. Enter the desired group name in the **Name** field.
4. Press  or  , or the **Switch** soft key to select the desired group ring tone from the **Ring** field.

If **Auto** is selected, this group will use the ring tone according to the priority: Contact ring tone (refer to [Adding Contacts](#)) >Account ring tone (refer to [Ring Tones](#)) >Phone ring tone (refer to [Ring Tones](#)). If a specific ring tone is selected, this group will use the ring tone according to the priority: Contact ring tone (refer to [Adding Contacts](#)) >Group ring tone.



5. Press the **Save** soft key to accept the change or the **Back** soft key to cancel.

## Editing Groups

### To edit a group in the local directory:

1. Press the **Directory** soft key.

The IP phone enters the local directory directly as there is only Local Directory enabled in the directory by default.



If Local Directory is removed from the directory (refer to [Directory](#) on page 59), press **Menu->Directory->Local Directory** to enter the local directory.

2. Select the desired contact group.

3. Press the **Option** soft key, and then select **Detail** from the prompt list.



4. Press  $\uparrow$  or  $\downarrow$  to highlight the group information and then edit.
5. Press the **Save** soft key to accept the change or the **Back** soft key to cancel.

## Deleting Groups

### To delete a group from the local directory:

1. Press the **Directory** soft key.

The IP phone enters the local directory directly as there is only Local Directory enabled in the directory by default.



If Local Directory is removed from the directory (refer to [Directory](#) on page 59), press **Menu->Directory->Local Directory** to enter the local directory.

2. Select the desired contact group.
3. Press the **Option** soft key, and then select **Delete** from the prompt list.

The LCD screen prompts the following warning:



4. Press the **OK** soft key to confirm the deletion or the **Cancel** soft key to cancel.

You can also delete all groups by pressing the **Option** soft key, and then select **Delete All**.

## Adding Contacts

You can add contacts to the local directory in one of the following ways:

- Manually
- From call history
- From a remote phone book

### Adding Contacts Manually

**To add a contact to the local directory manually:**

1. Press the **Directory** soft key.

The IP phone enters the local directory directly as there is only Local Directory enabled in the directory by default.



If Local Directory is removed from the directory (refer to [Directory](#) on page 59), press **Menu->Directory->Local Directory** to enter the local directory.

2. Select the desired contact group and then press the **Enter** soft key.

If the contact you want to add doesn't belong to any group, select **All Contacts** and then press the **Enter** soft key.

3. Press the **Add** soft key.
4. Enter the name and the office, mobile or other numbers in the corresponding fields.

Add Contact	
1. Name:	A
2. Office Number:	123
3. Mobile Number:	234
4. Other Number:	
5. Account:	Auto

Back      Switch      Save

5. Press  $\leftarrow$  or  $\rightarrow$ , or the **Switch** soft key to select the desired account from the **Account** field.

If **Auto** is selected, the phone will use the default account when placing calls to the contact from the local directory.

6. Press  $\leftarrow$  or  $\rightarrow$ , or the **Switch** soft key to select the desired ring tone from the **Ring** field.

If **Auto** is selected, this contact will use the ring tone according to the priority: Group ring tone (refer to [Adding Groups](#)) > Account ring tone (refer to [Ring Tones](#)) > Phone ring tone (refer to [Ring Tones](#)).

7. Press  $\leftarrow$  or  $\rightarrow$ , or the **Switch** soft key to select the desired group from the **Group** field.
8. Press  $\uparrow$  or  $\downarrow$  to select **Photo** field and then press the **Enter** soft key.
9. Press  $\leftarrow$  or  $\rightarrow$ , or the **Switch** soft key to select the desired photo from the **Photo** field.
10. Press the **Save** soft key to accept the change or the **Back** soft key to cancel.

#### Note

If the contact already exists in the directory, the LCD screen will prompt "Contact name existed!".

## Adding Contacts from Call History

### To add a contact to the local directory from call history:

1. Press the **History** soft key.
2. Press  $\uparrow$  or  $\downarrow$  to highlight the desired entry.

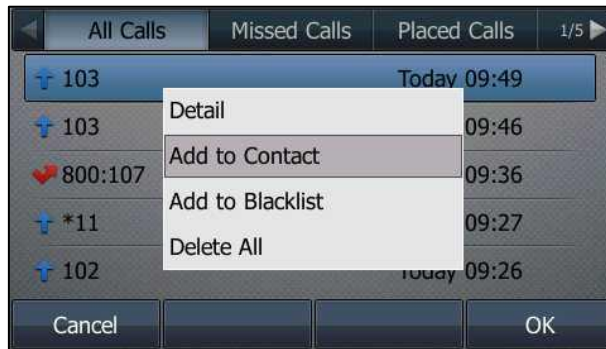

3. Press the **Option** soft key, and then select **Add to Contact** from the prompt list.



4. Press the **OK** soft key. And then enter the contact name.
5. Press the **Save** soft key to accept the change.  
The entry is successfully saved to the local directory.

## Adding Contacts from Remote Phone Book

**To add a contact to the local directory from remote phone book:**

1. Press **Menu->Directory->Remote Phone Book**.  
If Remote Phone Book is added to the directory (refer to [Directory](#) on page 59), press **Directory->Remote Phone Book** to enter the remote phone book.
2. Select the desired remote group and then press the **Enter** soft key.
3. Press  or  to highlight the desired entry.
4. Press the **Option** soft key, and then select **Add to Contact** from the prompt list.
5. Press the **Save** soft key to save the contact to the local directory.

If the contact already exists in the local directory, the LCD screen will prompt "Overwrite the original contact?". Press the **OK** soft key to overwrite the original contact in the local directory or the **Cancel** soft key to cancel.

For more information on remote phone book operating, refer to [Remote Phone Book](#) on page 76.

## Editing Contacts

**To edit a contact in the local directory:**

1. Press the **Directory** soft key.







The IP phone enters the local directory directly as there is only Local Directory enabled in the directory by default.



If Local Directory is removed from the directory (refer to [Directory](#) on page 59), press **Menu->Directory->Local Directory** to enter the local directory.

2. Select the desired contact group and then press the **Enter** soft key.

If the contact is not in any group, select **All Contacts** and then press the **Enter** soft key

3. Press  or  to highlight the desired contact.
4. Press the **Option** soft key, and then select **Detail** from the prompt list.
5. Press  or  to highlight the contact information and then edit.

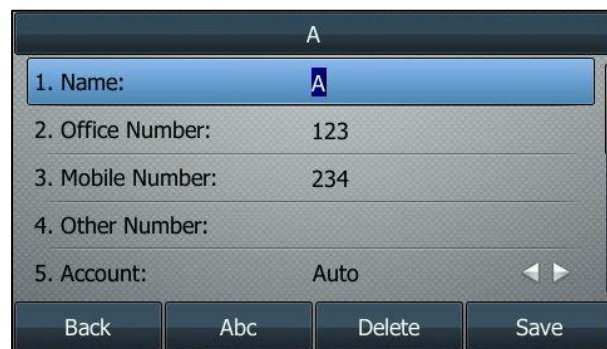

6. Press the **Save** soft key to accept the change or the **Back** soft key to cancel.

## Deleting Contacts

**To delete a contact from the local directory:**

1. Press the **Directory** soft key.

The IP phone enters the local directory directly as there is only Local Directory enabled in the directory by default.



If Local Directory is removed from the directory (refer to [Directory](#) on page 59), press **Menu->Directory->Local Directory** to enter the local directory.

2. Select the desired contact group and then press the **Enter** soft key.

If the contact is not in any group, select **All Contacts** and then press the **Enter** soft key

3. Press or to highlight the desired contact.
4. Press the **Option** soft key, and then select **Delete** from the prompt list.

The LCD screen prompts the following warning:

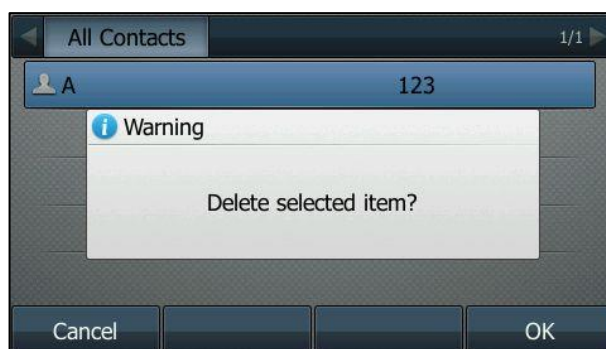

5. Press the **OK** soft key to confirm the deletion or the **Cancel** soft key to cancel.

You can also delete all contacts by pressing the **Option** soft key, and then select **Delete All**.

## Uploading Contact Photos

**To upload a new custom photo for the contact via web user interface:**

1. Click on **Directory->Local Directory**.
2. Click **Browse**, and then select a photo from your local computer.
3. Click **Upload Photo** to upload the photo.

You can also click **Delete Photo** to delete the photo.

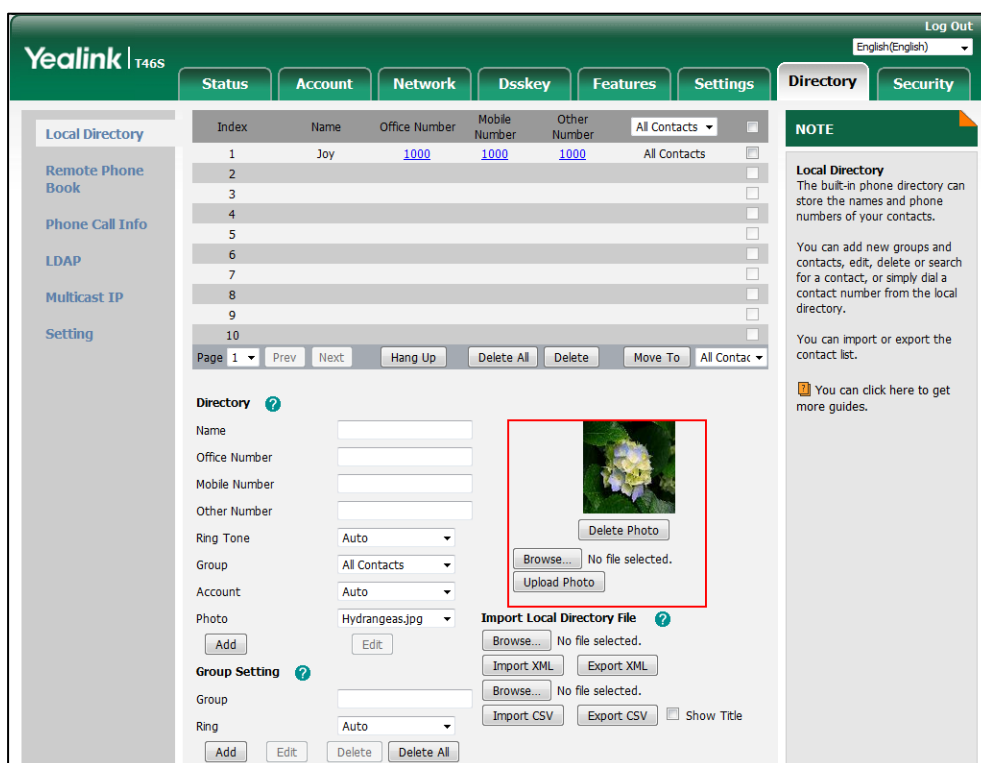

**Note**

The phone only supports \*.png, \*.jpg and \*.bmp format files.  
You can only delete custom photos.

**To change the custom photo for the contact via web user interface:**

1. Click on **Directory->Local Directory**.
2. Click to select the desired entry which you want to edit.
3. Select the desired photo from the pull-down list of **Photo**.

4. Click **Edit** to accept the change.

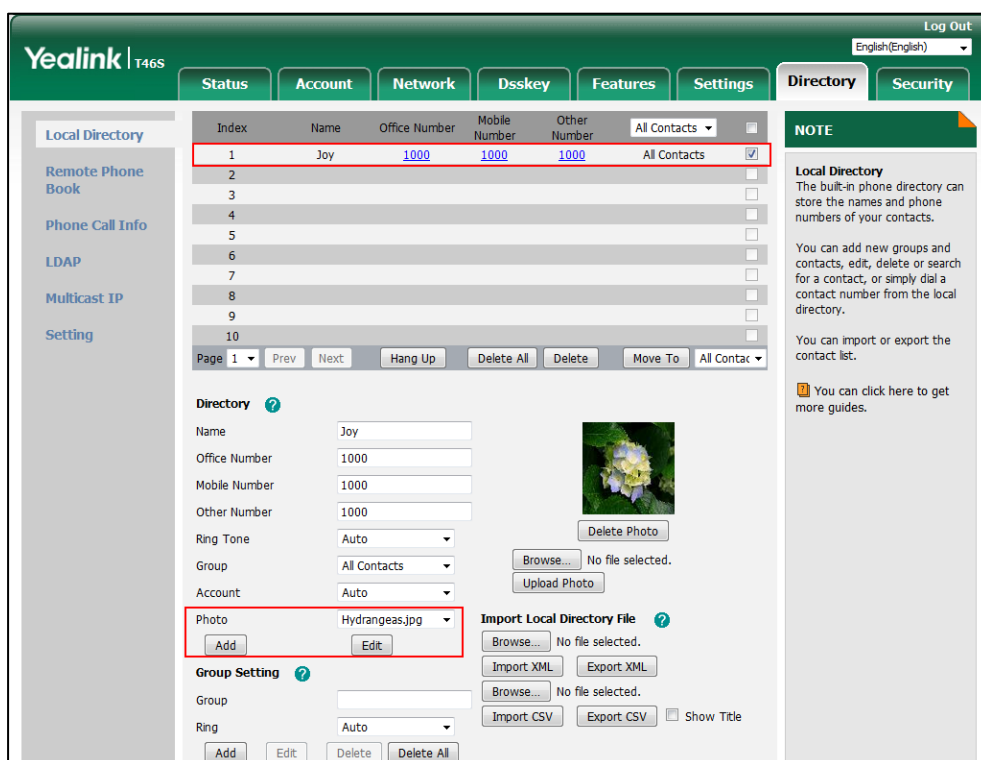

When you place a call to the contact or receive a call from the contact, the LCD screen will show the contact photo.

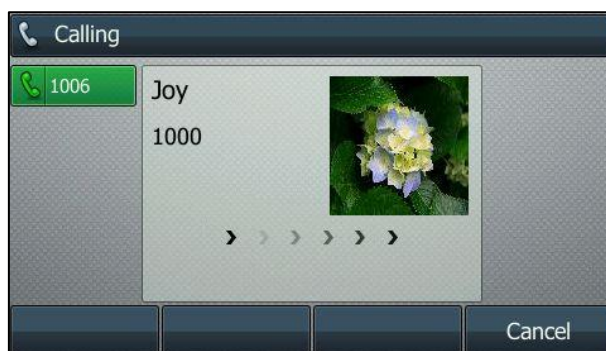

## Placing Calls to Contacts

**To place a call to a contact from the local directory:**

1. Press the **Directory** soft key.



The IP phone enters the local directory directly as there is only Local Directory enabled in the directory by default.



If Local Directory is removed from the directory (refer to [Directory](#) on page 59), press **Menu->Directory->Local Directory** to enter the local directory.

2. Select the desired contact group and then press the **Enter** soft key.

If the contact is not in any group, select **All Contacts** and then press the **Enter** soft key.

3. Press  or  to highlight the desired contact.

4. Do one of the following:

- If only one number for the contact is stored in the local directory, press the **Send** soft key to dial out the number.
- If multiple numbers for the contact are stored in the local directory, press the **Send** soft key to display a list of numbers.

Press  or  to highlight the desired number.

Press the **Send** soft key to dial out the number.

## Searching for Contacts

**To search for a contact in the local directory:**

1. Press the **Directory** soft key.

The IP phone enters the local directory directly as there is only Local Directory enabled in the directory by default.



If Local Directory is removed from the directory (refer to [Directory](#) on page 59), press

**Menu->Directory->Local Directory** to enter the local directory.

2. Press the **Search** soft key.
3. Enter a few continuous characters of the contact name or continuous numbers of the contact number (office, mobile or other number) using the keypad.



The contacts whose name or phone number matches the characters entered will appear on the LCD screen. You can dial from the result list.

## Importing/Exporting Contact Lists

You can manage your phone's local directory via phone user interface or web user interface. But you can only import or export the contact list via web user interface.

**To import an XML contact list file via web user interface:**

1. Click on **Directory->Local Directory**.
2. Click **Browse** to locate a contact list file (the file format must be \*.xml) from your local system.

3. Click **Import XML** to import the contact list.

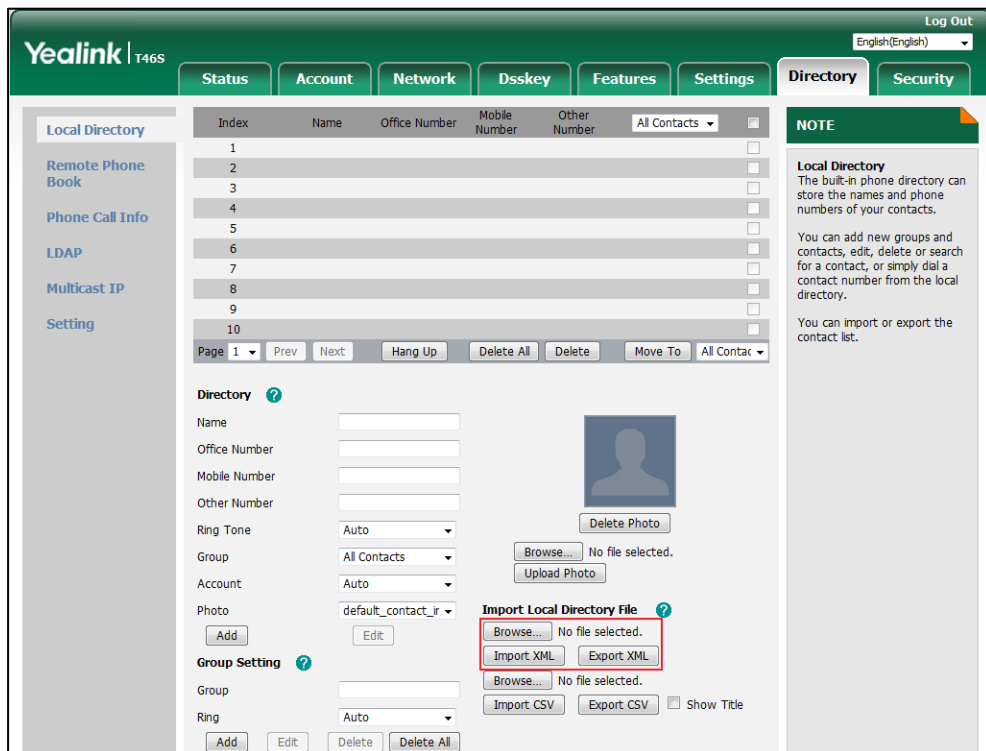

The web user interface prompts "The original contact will be covered, continue?".

4. Click **OK** to complete importing the contact list.

#### To import a CSV contact list file via web user interface:

1. Click on **Directory->Local Directory**.
2. Click **Browse** to locate a contact list file (the file format must be \*.csv) from your local system.
3. (Optional.) Check the **Show Title** checkbox.

It will prevent importing the title of the contact information which is located in the first line of the CSV file.

4. Click **Import CSV** to import the contact list.
5. (Optional.) Mark the **On** radio box in the **Delete Old Contacts** field.

It will delete all existing contacts while importing the contact list.

6. (Optional.) Select the contact information you want to import into the local directory from the pull-down list of **Index**.

At least one item should be selected to be imported into the local directory.

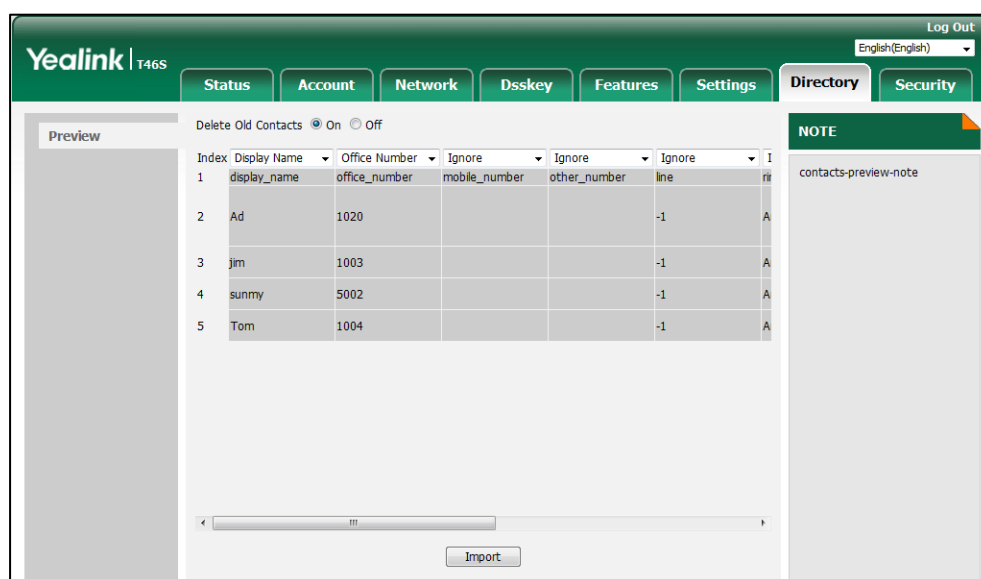

7. Click **Import** to complete importing the contact list.

#### To export a contact list via web user interface:

1. Click on **Directory->Local Directory**.
2. Click **Export XML** (or **Export CSV**).
3. Click **Save** to save the contact list to your local system.

#### Note

Importing/exporting contact lists is available via web user interface only.

## Blacklist

The built-in phone directory can store names and phone numbers for a blacklist. You can store up to 30 contacts, add, edit, delete or search for a contact in the blacklist directory, and even call a contact from the blacklist directory. Incoming calls from blacklist directory contacts will be rejected automatically.

#### To add a contact to the blacklist directory manually:

1. Press **Menu->Directory->Blacklist**.
2. Press the **Add** soft key.



3. Enter the name and the office, mobile or other numbers in the corresponding fields.

4. Press or , or the **Switch** soft key to select the desired account from the **Account** field.

If **Auto** is selected, the phone will use the default account when placing calls to the contact from the blacklist directory.

5. Press the **Save** soft key to accept the change or the **Back** soft key to cancel.

**To add a contact to the blacklist directory from the local directory:**

1. Press **Directory** soft key.

The IP phone enters the local directory directly as there is only Local Directory enabled in the directory by default.

If Local Directory is removed from the directory (refer to [Directory](#) on page 59), press **Menu->Directory->Local Directory** to enter the local directory.

2. Select the desired contact group and then press the **Enter** soft key.  
If the contact is not in any group, select **All Contacts** and then press the **Enter** soft key.
3. Press or to highlight the desired contact.
4. Press the **Option** soft key, and then select **Add to Blacklist** from the prompt list.

The LCD screen prompts the following warning:

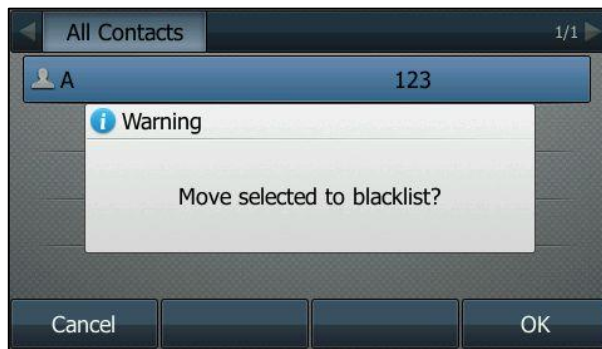

5. Press the **OK** soft key to accept the change.

For operating instructions on editing, deleting, placing calls to and/or searching for contacts in the blacklist directory, refer to the operating instructions of [Editing Contacts](#) on page 66, [Deleting Contacts](#) on page 67, [Placing Calls to Contacts](#) on page 70 and/or [Searching for Contacts](#) on page 71.

## Remote Phone Book

You can add new contacts to the local directory, search for a contact, or simply dial a contact number from the remote phone book.

You can configure your new phone to access up to 5 remote phone books. For the access URL of the remote phone book, contact your system administrator.

For operating instructions on placing calls to and/or searching for contacts in the remote phone book, refer to the operating instructions of [Placing Calls to Contacts](#) on page 70 and/or [Searching for Contacts](#) on page 71.

## Configuring an Access URL

**To configure an access URL for a remote phone book via web user interface:**

1. Click on **Directory**->**Remote Phone Book**.
2. Enter the access URL in the **Remote URL** field.

- Enter the name in the **Display Name** field.

Index	Remote URL	Display Name
1	http://192.168.0.10/Department.xml	Group One
2		
3		
4		
5		

Incoming/Outgoing Call Lookup: Enabled

Update Time Interval(Seconds): 21600

**NOTE**  
**Remote Phone Book**  
 It is a centrally maintained phone book, stored on the remote server.  
 Users only need the access URL of the remote phone book. The IP phone can establish a connection with the remote server and download the phone book, and then display the remote phone book entries on the phone user interface.

- Click **Confirm** to accept the change.

**Note** An access URL for a remote phone book is configurable via web user interface only.

## Accessing the Remote Phone Book

**To access your remote phone book via phone user interface:**

- Press **Menu->Directory->Remote Phone Book**.

If Remote Phone Book is added to the directory (refer to [Directory](#) on page 59), press **Directory->Remote Phone Book** to enter the remote phone book.

- Select the desired remote group, and then press the **Enter** soft key.

The phone then connects to the remote phone book and proceeds to load it. The contacts in the remote phone book are displayed on the LCD screen.



- Press the **Back** soft key to back to the previous screen.

**Note** An access URL for a remote phone book is configurable via web user interface only.  
 The size of a remote phone book file should be less than 1.5M.

## Incoming/Outgoing Call Lookup

You can enable the phone to present the caller/callee identity stored in the remote phone book

when receiving/placing a call.

**To configure incoming/outgoing call lookup and update time interval via web user interface:**

1. Click on **Directory**->**Remote Phone Book**.
2. Select **Enabled** from the pull-down list of **Incoming/Outgoing Call Lookup**.
3. Enter the desired refresh period in the **Update Time Interval(Seconds)** field.

The default value is 21600.

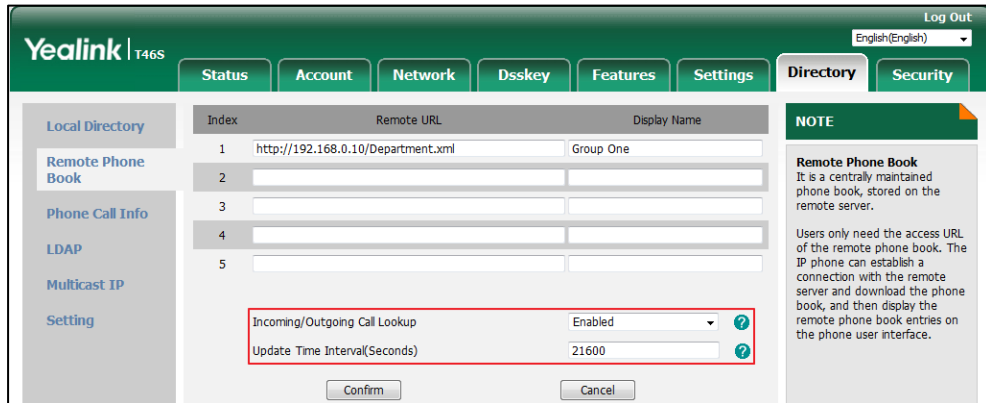

4. Click **Confirm** to accept the change.

## Call History Management

The SIP-T46S IP phone maintains call history lists of Missed Calls, Placed Calls, Received Calls and Forwarded Calls. Each call history list supports up to 100 entries. You can view call history, place a call, add a contact or delete an entry from the call history list.

History record feature is enabled by default. If you don't want to save the call history, you can disable the feature.





## Viewing History Records

**To view call history:**

1. Press the **History** soft key.  
The LCD screen displays all call records.
2. Press **◀** or **▶** to switch among **All Calls**, **Missed Calls**, **Placed Calls**, **Received Calls** and **Forwarded Calls**.
3. Press **▲** or **▼** to select the desired entry.
4. Press the **Option** soft key, and then select **Detail** from the prompt list.  
The detailed information of the entry appears on the LCD screen.





## Placing a Call from History Records

### To place a call from the call history list:

1. Press the **History** soft key.
2. Press  or  to switch among **All Calls**, **Missed Calls**, **Placed Calls**, **Received Calls** and **Forwarded Calls**.
3. Press  or  to select the desired entry.
4. Press the **Send** soft key.

## Adding a Contact to the Local Directory/Blacklist





### To add a contact to the local directory (or blacklist directory) from the call history list:

1. Press the **History** soft key.
2. Press  or  to switch among **All Calls**, **Missed Calls**, **Placed Calls**, **Received Calls** and **Forwarded Calls**.
3. Press  or  to select the desired entry.
4. Press the **Option** soft key, and then select **Add to Contact** (or **Add to Blacklist**) from the prompt list.
5. Enter the desired values in the corresponding fields.
6. Press the **Save** soft key.



For more information on local directory and/or blacklist, refer to [Local Directory](#) on page 61 and/or [Blacklist](#) on page 74.

## Deleting History Records

### To delete an entry from the call history list:

1. Press the **History** soft key.
2. Press  or  to switch among **All Calls**, **Missed Calls**, **Placed Calls**, **Received Calls** and **Forwarded Calls**.
3. Press  or  to select the desired entry.
4. Press the **Delete** soft key.

### To delete all entries from the call history list:

1. Press the **History** soft key.
2. Press  or  to switch among **All Calls**, **Missed Calls**, **Placed Calls**, **Received Calls** and **Forwarded Calls**.
3. Press the **Option** soft key, and then select **Delete All** from the prompt list.
4. Press the **OK** soft key.

The LCD screen prompts "Delete all the call records?".



5. Press the **OK** soft key to confirm the deletion or the **Cancel** soft key to cancel.

## Disabling History Record

**To disable history record via phone user interface:**

1. Press **Menu->Features->Others->General**.
2. Press **◀** or **▶**, or the **Switch** soft key to select **Disabled** from the **History Record** field.



3. Press the **Save** soft key to accept the change or the **Back** soft key to cancel.

## Search Source List in Dialing

You can search for a contact from the desired lists when the phone is on the dialing screen. The lists can be Local Directory, History, Remote Phone Book and LDAP.



**Note** LDAP is disabled by default. For more information, contact your system administrator.

**To configure search source list in dialing via web user interface:**

1. Click on **Directory->Setting**.
2. In the **Search Source List In Dialing** block, select the desired list from the **Disabled** column

and click  .

The selected list appears in the **Enabled** column.

3. Repeat the step 2 to add more lists to the **Enabled** column.
4. To remove a list from the **Enabled** column, select the desired list and then click  .
5. To adjust the display order of the enabled list, select the desired list, and click  or  .

The LCD screen will display search results in the adjusted order.

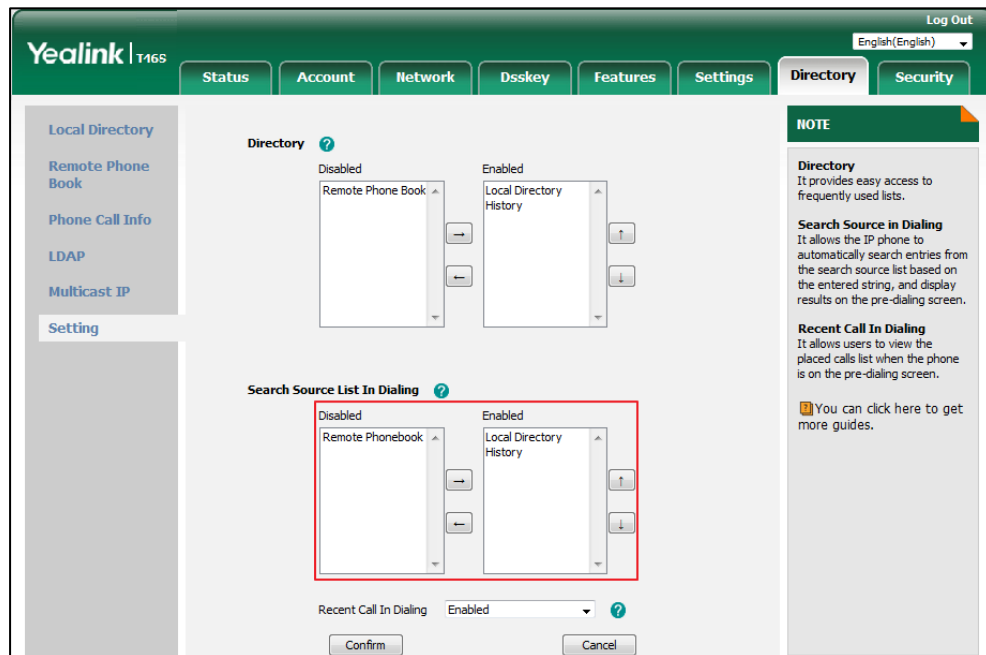



6. Click **Confirm** to accept the change.

**Note** Search source list in dialing is configurable via web user interface only.

**To search for an entry in the enabled search source lists:**

1. Pick up the handset, press the Speakerphone key or press the line key.
2. Enter a few continuous characters of the entry's name or continuous numbers of the entry's phone number (office, mobile or other number) using the keypad.

The entries in the enabled search source lists whose name or phone number matches the characters entered will appear on the LCD screen. You can press  or  to scroll to the desired entry and then place a call to the entry.

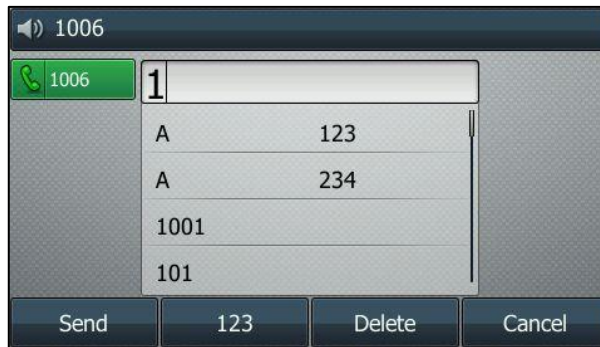

## System Customizations

### Headset Use

If you want to use a wired headset, physically connect your headset to the phone and activate the headset mode for use. For more information on physically connecting a headset, refer to [Phone Installation](#) on page 20.

If you want to use a wireless headset, insert the Bluetooth USB dongle into the USB port at the back of the IP phone. For more information on using a Bluetooth headset, refer to [Bluetooth Headset](#) on page 84.

This section provides an introduction to wired headset use.

#### Note

If both a Bluetooth headset and a wired headset are connected, only the Bluetooth headset can be used.

To use headset, make sure the headset mode is enabled. Contact your system administrator for more information.

### Headset Mode Activation/Deactivation

#### To activate the headset mode:

1. Press  on the phone.



The HEADSET key LED illuminates solid green and the headset icon  appears on the idle screen.

Press the line key or the **Answer** soft key to answer an incoming call. The call will be connected to your headset automatically.

Enter the desired number and then press the **Send** soft key, the phone will then place a call using the headset automatically. For more information on using the headset to place a call, refer to [Placing Calls](#) on page 115.



**To deactivate the headset mode:**

1. Press  again on the phone.  
The HEADSET key LED goes out and the headset icon  disappears from the idle screen.

## Headset Prior

You can use headset in priority when headset prior feature is enabled. This feature is especially useful for permanent or full-time headset users.

**To enable headset prior via web user interface:**

1. Click on **Features->General Information**.
2. Select **Enabled** from the pull-down list of **Headset Prior**.

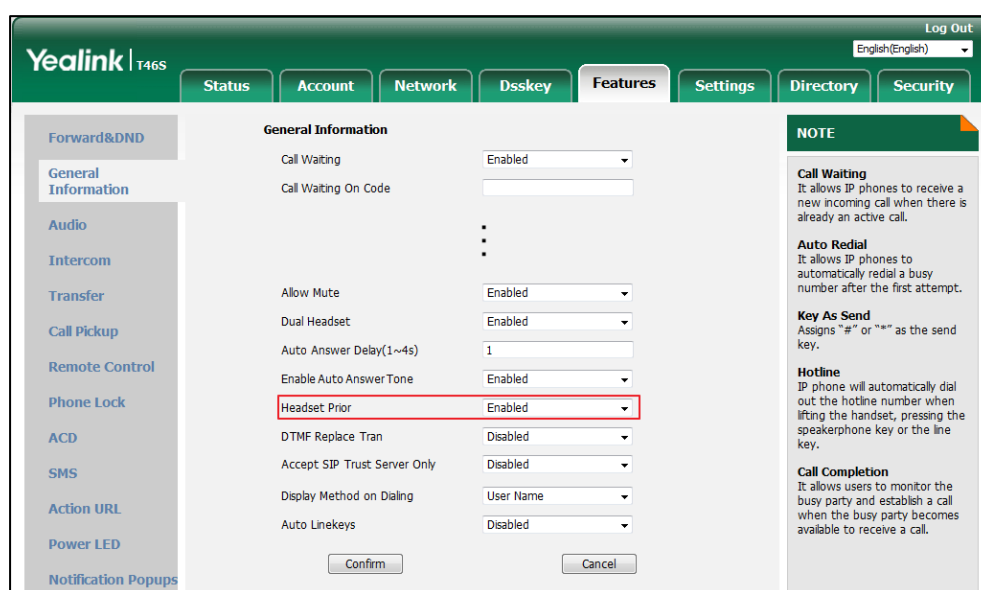

3. Click **Confirm** to accept the change.

**To use headset prior, you should activate the headset mode in advance:**

1. Physically connect the headset.
2. Press  to activate the headset mode.

**Note**

If headset prior is enabled, the headset mode will not be deactivated until you press the **HEADSET** key again.

If headset prior is disabled, the headset mode can be deactivated by pressing the Speakerphone key or the **HEADSET** key.

Headset prior is configurable via web user interface only.

## Dual Headset

You can use two headsets when dual headset feature is enabled. To use this feature, you must physically connect headsets to the headset jack and handset jack respectively. Once the phone

connects to a call, the headset connected to the headset jack will have full-duplex capabilities, while the one connected to the handset jack will only be able to listen.

**To enable dual headset via web user interface:**

1. Click on **Features->General Information**.
2. Select **Enabled** from the pull-down list of **Dual Headset**.

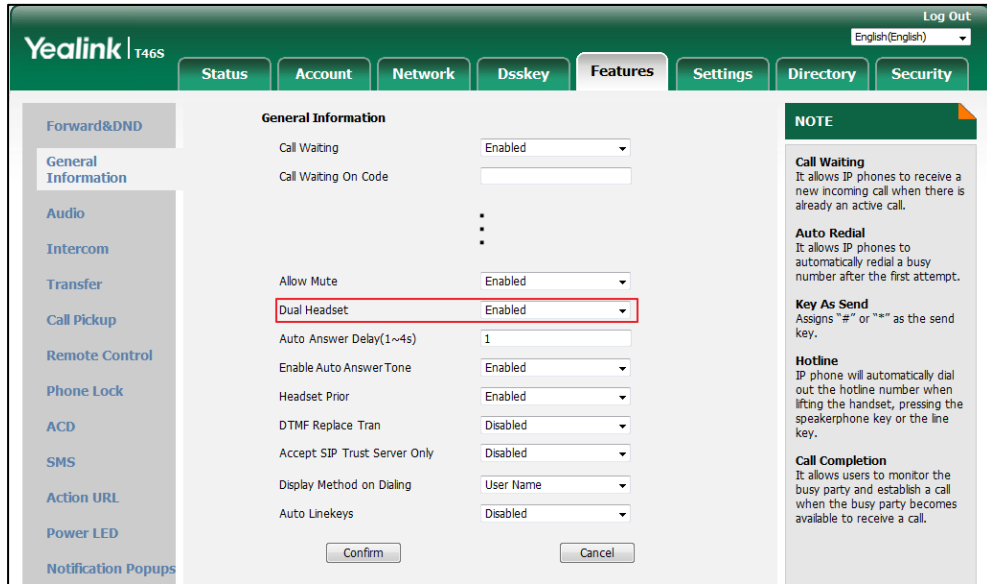

3. Click **Confirm** to accept the change.

**Note** Dual headset is configurable via web user interface only.

## Bluetooth Headset

The SIP-T46S IP phone supports Bluetooth. Bluetooth enables low-bandwidth wireless connections within a range of 10 meters (32 feet). The best performance is in the 1 to 2 meters (3 to 6 feet) range.

You can activate/deactivate the Bluetooth mode on the phone, and then pair and connect the Bluetooth headset with your phone. You can pair up to 30 Bluetooth headsets with your phone. However, only one headset can be connected at a time. You can also disconnect and delete your Bluetooth headset from the phone.



**Note** Ensure that the Bluetooth USB dongle is properly connected to the USB port at the back of the IP phone. For more information, refer to [Phone Installation](#) on page 20.

## Activating the Bluetooth Mode

When you insert Bluetooth USB dongle BT40 into the USB port at the back of the IP phone, the LCD screen prompts "Adapter has been added, scanning the bluetooth devices right now?". You can press the **OK** soft key to enter the Bluetooth screen. You can activate Bluetooth mode and then scan Bluetooth devices.



**To activate the Bluetooth mode via phone user interface:**

1. Press **Menu->Basic->Bluetooth**.
2. Press  or , or the **Switch** soft key to select **On** from the **Bluetooth** field.



3. Press the **Save** soft key to accept the change.

The LCD screen displays the Bluetooth icon .

Bluetooth mode is configurable via web user interface at the path **Features->Bluetooth**.

## Pairing and Connecting the Bluetooth Headset

Before you pair a Bluetooth headset, check the indicator on the Bluetooth headset to make sure that the Bluetooth headset is discoverable. For more information, refer to the documentation from the Bluetooth headset manufacturer.

**To pair and connect your Bluetooth headset to your IP phone:**

1. Press **Menu->Basic->Bluetooth**.
2. Press the **Scan** soft key to search the Bluetooth devices.

The LCD screen prompts the following message:

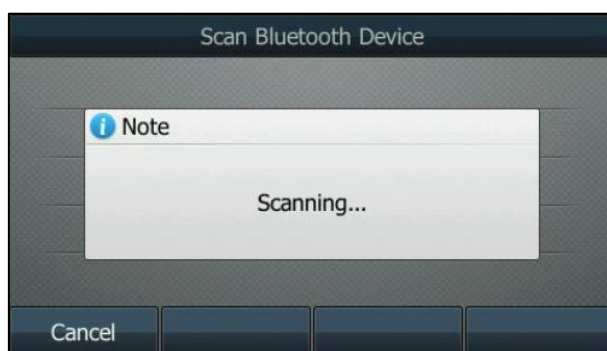

The phone proceeds to scan the local Bluetooth devices. When the phone completes scanning, it will display the available Bluetooth devices on the LCD screen.



3. Select the desired Bluetooth headset and then press **Connect** soft key.
4. Enter the desired PIN in the **Password** field.

The default PIN is "0000".



5. Press the **OK** soft key.

The Bluetooth headset is then automatically connected to your IP phone.

The Bluetooth icon  appears on the LCD screen.

With the Bluetooth headset paired and connected, you can use the Bluetooth headset to place and answer calls. For more information, refer to the documentation from the Bluetooth headset manufacturer.

## Viewing the Bluetooth Headset Information

**To view the Bluetooth headset information:**

1. Press **Menu->Basic->Bluetooth->Paired Bluetooth Device**.

The LCD screen displays a list of paired and connected Bluetooth headsets.



2. Select the desired Bluetooth headset.
3. Press the **Option** soft key, and then select **Detail** from the prompt list to view the Bluetooth headset information:
  - **Device Name:** the name of the Bluetooth headset.
  - **MAC Address:** the MAC address of the Bluetooth headset.

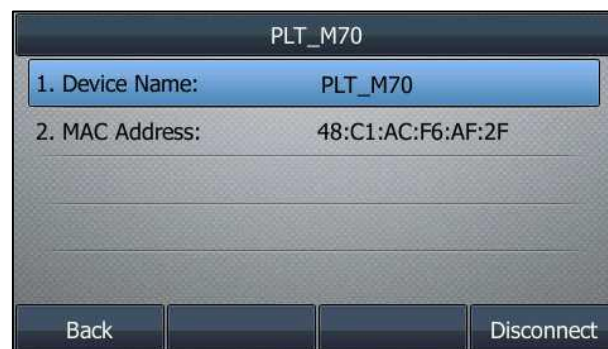

## Editing Device Information

**To edit device information via phone user interface:**

1. Press **Menu->Basic->Bluetooth->Edit My Device Information**.

The LCD screen displays the device name and MAC address. The MAC address cannot be edited.

2. Enter the desired name in the **Device Name** field.

The default device name is "Yealink T46S".

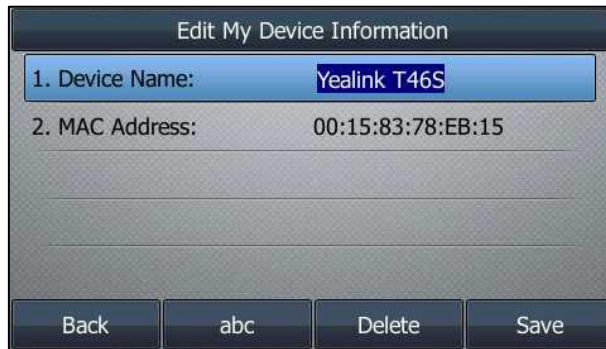

3. Press the **Save** soft key to accept the change or the **Back** soft key to cancel.

The preconfigured Bluetooth device name will display in scanning list of other devices.

## Disconnecting the Bluetooth Headset

You can disconnect the Bluetooth headset from your phone. After you disconnect the Bluetooth headset, it will still remain paired and be displayed in the **Paired Bluetooth Device** list. So you can easily connect it to your IP phone again.

### To disconnect your Bluetooth headset from your phone:

1. Press **Menu->Basic->Bluetooth->Paired Bluetooth Device**.
2. Select the connected Bluetooth headset.
3. Press the **Disconnect** soft key.

The Bluetooth headset is disconnected. To connect it to your IP phone again, press the **Connect** soft key.

## Deleting the Paired Bluetooth Headset

You can delete your Bluetooth headset from your phone. When you delete the Bluetooth headset, it disappears from the **Paired Bluetooth Device** list. To connect it to your IP phone again, you need to scan and connect it again.

### To delete your Bluetooth headset from your phone:

1. Press **Menu->Basic->Bluetooth->Paired Bluetooth Device**.
2. Select the Bluetooth headset you want to delete.
3. Press the **Option** soft key, and then select **Delete** from the prompt list.

The LCD screen prompts the following warning "Delete selected item?".

4. Press the **OK** soft key to confirm the deletion or the **Cancel** soft key to cancel.



**Note**

You can also delete all headsets by pressing the **Option** soft key and then select **Delete All**. For more information, refer to the above steps.

If you cannot connect a Bluetooth headset to the phone successfully, we recommend that you delete the Bluetooth headset from the **Paired Bluetooth Device** list (if it exists) before pairing it.

## Deactivating the Bluetooth Mode

**To deactivate the Bluetooth mode via phone user interface:**

1. Press **Menu->Basic->Bluetooth**.
2. Press  or , or the **Switch** soft key to select **Off** from the **Bluetooth** field.



3. Press the **Save** soft key to accept the change.

The Bluetooth icon  disappears from the phone.

The Bluetooth headset won't be connected anymore, but it will still be paired. When you activate the Bluetooth mode again, the paired Bluetooth headset will appear in the **Paired Bluetooth Devices** list.

Bluetooth mode is configurable via web user interface at the path **Features->Bluetooth**.

## DSS Keys

There are three types of DSS keys: Line Keys, Programable Keys and Ext Keys. Details will be introduced in the following. The SIP-T46S IP phone supports 27 line keys and 13 programable keys.

### Line Keys

You can assign predefined functionalities to line keys. You can also define a label for a line key feature which will appear on the LCD screen. Line keys allow you to quickly access features such as recall and voice mail. The line key LEDs will indicate the monitored status when the line keys are assigned with particular features, such as BLF. The default key type of line key 1-16 is Line. The default key type of line key 17-27 is N/A, which indicates that this line key provides no

functionality until configuration.

**To assign functionality to a line key via phone user interface:**

1. Press **Menu**->**Features**->**DSS Keys**.
2. Select the desired line key, and then press the **Enter** soft key.
3. Select the desired key type from the **Type** field.
4. (Optional.) Select the desired key event type from the **Key Type** field.
5. (Optional.) Select the desired line from the **Account ID** field.
6. (Optional.) Enter the string that will appear on the LCD screen in the **Label** field.
7. (Optional.) Enter the corresponding value in the **Value** field.
8. (Optional.) Enter the corresponding value in the **Extension** field.
9. Press the **Save** soft key to accept the change or the **Back** soft key to cancel.

Line key is configurable via web user interface at the path **Dsskey**->**Line Key**.

**Note** When the phone is idle, you can also long press the line key to configure it directly on the phone.

You can assign functionalities to 27 line keys. These 27 line keys are indicated on three pages. When you assign functionality to line keys located in line key 1-10, the labels of line keys are indicated on the first page. The following figure shows an example:







When you assign functionality to line key located in line key 11-27, the label of the line key 10-18 are indicated on the second page, and the labels of the line key 19-27 are indicated on the third page. The line key in the right bottom is used to switch pages. The following figure shows an example:





The following table lists the page icons:

Icons	Description
	Indicates the current page of line keys.
	Indicates the non-current page of line keys.

### Page Tips

You can use page tips feature to enable the page icon and page switch key LED to indicate different statuses. This feature is disabled by default.

The following table lists the page icons to indicate different statuses:

Icons	Description
	Fast-flashing: the BLF monitored user receives an incoming call on the non-current page. Solid: there is a parked call on the non-current page.
	Fast-flashing: the line receives an incoming call on the non-current page.

For more information on the page switch key LED status, refer to [LED Instructions](#) on page 9.

**To configure the page icon to indicate status via web user interface:**

1. Click on **Dsskey->Line Key**.
2. Select **Enabled** from the pull-down list of **Enable Page Tips**.

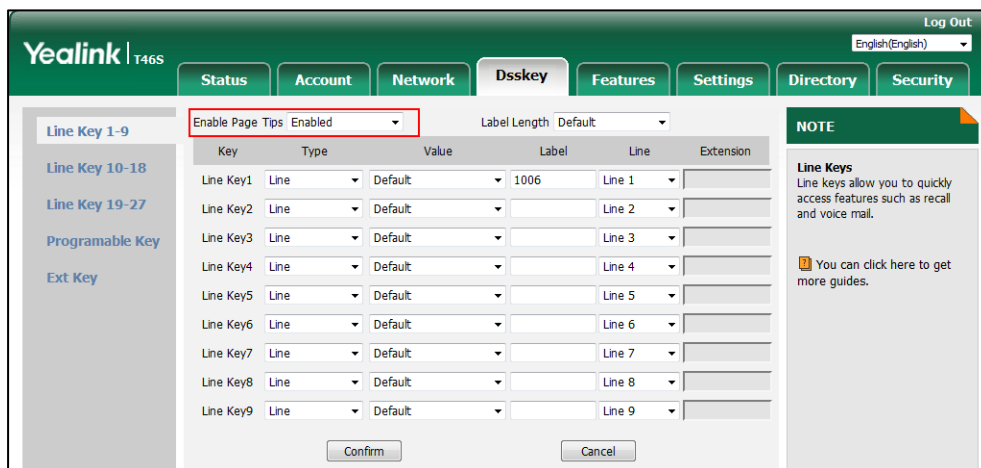

3. Click **Confirm** to accept the change.

**Note** Page tips features are configurable via web user interface only.

### Label Length

You can specify labels for some key features, which will be displayed on the idle LCD screen. If the length of the label exceeds the maximum display length, the phone will only display the first few characters. You can configure the phone to display more characters via label length feature.

The following figure shows an example of label display when the label length feature is set to Extended:



The following figure shows an example of label display when the label length feature is set to Mid-range:



The following figure shows an example of label display when the label length feature is set to Default:



**To configure the label length via web user interface:**

1. Click on **Dsskey**->**Line Key**.
2. Select **Extended** from the pull-down list of **Label Length**.

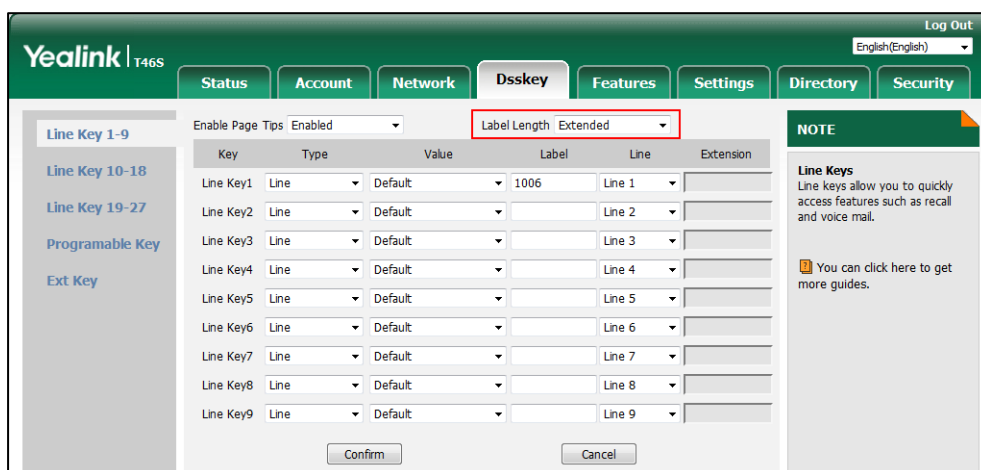

3. Click **Confirm** to accept the change.

**Note** Label length features are configurable via web user interface only.

## Line Key Features

Line key features are explained in the following subchapters in detail:

- Line
- Speed Dial
- Voice Mail
- Direct Pickup
- Group Pickup
- DTMF
- Prefix
- Local Group
- XML Group
- XML Browser
- LDAP
- Conference
- Forward
- Transfer
- Hold
- DND
- SMS
- Group Listening
- Zero Touch
- URL
- Phone Lock
- Directory

For the features not listed above, refer to [Basic Call Features](#) on page 115 and [Advanced Phone Features](#) on page 161. For more information, contact your system administrator.

### Line

You can use this key feature to accept incoming calls, place active calls on hold or resume a held call. It performs in the same way as a hard line key.

**Dependencies:** *Type (Line)*

*Account ID* (the account this feature will be applied to)

*Label* (key label displayed on the LCD screen)

*Value* (Default/Lock)

**Usage:** When the phone receives an incoming call, the **Line** key LED flashes green:

1. Press the **Line** key to accept the incoming call.
2. Press the **Line** key to place a new call and the active call is placed on hold.
3. Press the **Line** key again to resume the held call.

If you select **Lock** from the **Value** field, the line keys located in the same position of the other page will be automatically assigned Line feature with **Lock** filled in the **Value** field. This feature is only applicable to line key 1-9. Then you can use this key on every page. If you select **Default** from the **Value** field, you can only use this key on the current page.

### Speed Dial

You can use this key feature to speed up dialing the numbers frequently used or hard to remember.

#### Dependencies: *Type (SpeedDial)*

**Account ID** (the account this feature will be applied to)

**Label** (key label displayed on the LCD screen)

**Value** (the number you want to dial out)

**Usage:** Press the **Speed Dial** key to dial out the number specified in the **Value** field, using the account selected from the **Account ID** field.

### Voice Mail

You can use this key feature to quickly connect voice mail. For more information, refer to [Voice Mail](#) on page 215.

#### Dependencies: *Type (Key Event)*

**Key Type (Voice Mail)**

**Account ID** (the account this feature will be applied to)

**Label** (key label displayed on the LCD screen)

**Value** (the voice mail access code)

**Usage:** Press the **Voice Mail** key to dial out the voice mail access code. Then follow the voice prompt to listen to the voice mails.

### Direct Pickup

You can use this key feature to answer someone else's incoming call on the phone.

#### Dependencies: *Type (Key Event)*

**Key Type (DPickup)**

**Account ID** (the account this feature will be applied to)

**Label** (key label displayed on the LCD screen)

**Value** (the directed call pickup code followed by the target phone number)

**Usage:** Press the **Direct Pickup** key on your phone when the target phone number receives an incoming call. The call is then answered on your phone.

### Group Pickup

You can use this key feature to answer incoming calls in a group that is associated with their own group.

**Dependencies:** *Type (Key Event)*

*Key Type (GPickup)*

*Account ID (the account this feature will be applied to)*

*Label (key label displayed on the LCD screen)*

*Value (the group call pickup code)*

**Usage:** Press the **Group Pickup** key on your phone when a phone number in the group receives an incoming call. The call is answered on your phone.

### DTMF

You can use this key feature to send the specification of arbitrary key sequences via DTMF.

**Dependencies:** *Type (Key Event)*

*Key Type (DTMF)*

*Label (key label displayed on the LCD screen)*

*Value (DTMF sequence)*

**Usage:** Press the **DTMF** key during an active call to send the key sequence specified in the **Value** field.

### Note

DTMF sequence can only contain "0-9", "\*", "#" and "A-E".

### Prefix

You can use this key feature to add a specified prefix number before the dialed number.

**Dependencies:** *Type (Key Event)*

*Key Type (Prefix)*

*Label (key label displayed on the LCD screen)*

*Value (the prefix number)*

**Usage:** Press the **Prefix** key when the phone is idle, the phone will then enter the dialing screen and display the prefix number that you specified in the **Value** field. You can enter the remaining digits and then dial out.

### Local Group

You can use this key feature to quickly access a contact group in the local directory. For more information, refer to [Local Directory](#) on page 60.

**Dependencies:** *Type (Key Event)*

*Key Type (Local Group)*

*Local Group (the contact group name you want to access)*

*Label (key label displayed on the LCD screen)*

**Usage:** Press the **Local Group** key to access the contact group specified in the **Local Group** field.

### XML Group

You can use this key feature to quickly access a remote group in your remote phone book. You should configure remote phone book in advance. For more information, refer to [Remote Phone Book](#) on page 76.

**Dependencies:** *Type (Key Event)*

*Key Type (XML Group)*

*XML Group (the remote group name you want to access if remote phone book is configured)*

*Label (key label displayed on the LCD screen)*

**Usage:** Press the **XML Group** key to access the remote group specified in the **XML Group** field.

### XML Browser

You can use this key feature to quickly access an XML browser. The XML browser allows you to create custom services which meet your functional requirements on the server. You can customize practical applications, such as weather report, stock information, Google search, etc.

**Dependencies:** *Type (Key Event)*

*Key Type (XML Browser)*

*Label (key label displayed on the LCD screen)*

*Value (the access URL for XML browser)*

**Usage:** Press the **XML Browser** key to access the XML browser specified in the **Value** field.

### LDAP

You can use this key feature to quickly access a LDAP search screen.

**Dependencies:** *Type (Key Event)*

*Key Type (LDAP)*

*Label (key label displayed on the LCD screen)*

**Usage:**

1. Press the **LDAP** key to access the LDAP search screen.
2. Enter a few continuous characters of the contact name or continuous numbers of the contact number using the keypad.

The contacts whose name or phone number matches the characters entered will appear on the LCD screen.

#### Note

LDAP is disabled by default. For more information, contact your system administrator.

### Conference

You can use this key feature to set up a conference call. For more information, refer to [Conference](#) on page 145.

**Dependencies:** *Type (Key Event)*

*Key Type (Conference)*

*Label (key label displayed on the LCD screen)*

*Value (the number you want to add to the conference)*

**Usage:** Press the **Conference** key during an active call to set up a conference with the number specified in the **Value** field.

**Note**

If the **Value** field is left blank, the **Conference** key performs the same as the **Conference** soft key during a call.

### Forward

You can use this key feature to forward an incoming call to someone else. For more information, refer to [Call Forward](#) on page 133.

**Dependencies:** *Type (Key Event)*

*Key Type (Forward)*

*Label (key label displayed on the LCD screen)*

*Value (the number you want to forward to)*

**Usage:**

Press the **Forward** key to forward an incoming call to the number specified in the **Value** field.

**Note**

If the **Value** field is left blank, the **Forward** key performs the same as the **Forward** soft key when receiving an incoming call.

### Transfer

When there is an active call on the phone, you can use this key feature to handle the call differently depending on the transfer mode assigned to the DSS key.

**Dependencies:** *Type (Key Event)*

*Key Type (Transfer)*

*Label (key label displayed on the LCD screen)*

*Value (the number you want to transfer to)*

**Usage:**

- When the transfer mode on DSS key is **Blind Transfer**, press the **Transfer** key to complete the blind transfer to the number specified in the **Value** field.
- When the transfer mode on DSS key is **Attended Transfer**, press the **Transfer** key to dial out the number specified in the **Value** field, and then perform the attended or



semi-attended transfer.

- When the transfer mode on DSS key is **New Call**, press the **Transfer** key to place a new call to the number specified in the **Value** field.

#### Note

Transfer mode via DSS key is configurable via web user interface at the path **Features->Transfer->Transfer Mode Via Dsskey**.

If the **Value** field is left blank, the **Transfer** key performs the same as the **TRANSFER** key or the **Transfer** soft key during a call. For more information, refer to [Call Transfer](#) on page 141.

#### Hold

You can use this key feature to place an active call on hold or retrieve a held call.

**Dependencies:** *Type (Key Event)*

*Key Type (Hold)*

*Label (key label displayed on the LCD screen)*

**Usage:**

1. Press the **Hold** key during an active call to place the call on hold.
2. Press the **Hold** key again to retrieve the held call.

#### DND

You can use this key feature to activate or deactivate DND. You can also use this key feature to access the custom DND screen. For more information, refer to [Do Not Disturb \(DND\)](#) on page 128.

**Dependencies:** *Type (Key Event)*

*Key Type (DND)*

*Label (key label displayed on the LCD screen)*

**Usage:**

When DND is in phone mode:

1. Press the **DND** key to activate DND.
2. Press the **DND** key again to deactivate DND.

When DND is in custom mode:

1. Press the **DND** key to access the custom DND screen. You can activate or deactivate DND for one or all accounts.

#### Note

When DND is activated, the **DND** key LED will illuminate solid green, and the incoming calls will be rejected automatically.

#### SMS

You can use this key feature to quickly access text message. For more information, refer to [Short Message Service \(SMS\)](#) on page 213.

**Dependencies: Type (Key Event)**

**Key Type (SMS)**

**Label** (key label displayed on the LCD screen)

**Usage:** Press the **SMS** key when the phone is idle to access text message.

**Group Listening**

You can use this key feature to activate the Speakerphone and Handset/Headset mode at the same time. It is suitable for the group conversations which have more than one person present at one end. You are able to speak and listen through the handset/headset, while the others nearby can only listen through the speaker.

**Dependencies: Type (Key Event)**

**Key Type (Group Listening)**

**Label** (key label displayed on the LCD screen)

**Usage:**

1. During a call, press the **Group Listening** key to activate the group listening mode.  
You can then speak and listen through the handset/headset, while other people at your side can only listen through the speaker at the same time.
2. Press the **Group Listening** key again to deactivate the group listening mode.

**Zero Touch**

You can use this key feature to quickly configure auto provision and network parameters.

**Dependencies: Type (Key Event)**

**Key Type (Zero Touch)**

**Label** (key label displayed on the LCD screen)

**Usage:**

1. Press the **Zero Touch** key to access the zero touch screen.
2. Press the **OK** soft key within a few seconds.
3. Configure the network parameters in the corresponding fields.
4. Press the **Next** soft key.
5. Configure the auto provision parameters in the corresponding fields.
6. Press the **OK** soft key.  
The phone will reboot to update configurations.

**URL**

You can use this key feature to trigger the phone to send an HTTP GET request containing a specific URL.

**Dependencies: Type (URL)**

**Label** (key label displayed on the LCD screen)

**URL** (the URL contained in the HTTP GET request)

**Usage:** Press the **URL** key to trigger the phone to send an HTTP GET request containing the URL specified in the **URL** field.

### Phone Lock

You can use this key feature to immediately lock your phone instead of long pressing . For more information, refer to [Phone Lock](#) on page 52.

**Dependencies:** *Type (Key Event)*

*Key Type (Phone Lock)*

*Label (key label displayed on the LCD screen)*

**Usage:** When the phone lock feature is enabled, press the **Phone Lock** key to immediately lock your phone instead of long pressing .

### Directory

You can use this key feature to easily access frequently used lists. For more information, refer to [Directory](#) on page 59.

**Dependencies:** *Type (Key Event)*

*Key Type (Directory)*

*Label (key label displayed on the LCD screen)*

**Usage:** Press the **Directory** key to immediately access frequently used lists.

#### Note

The **Directory** key performs the same function as the **Directory** soft key when the phone is idle.

## Programmable Keys

You can customize the soft keys, navigation keys and function keys.

**To customize programmable keys via web user interface:**

1. Click on **Dsskey**->**Programmable Key**.

2. Customize specific features for these keys.

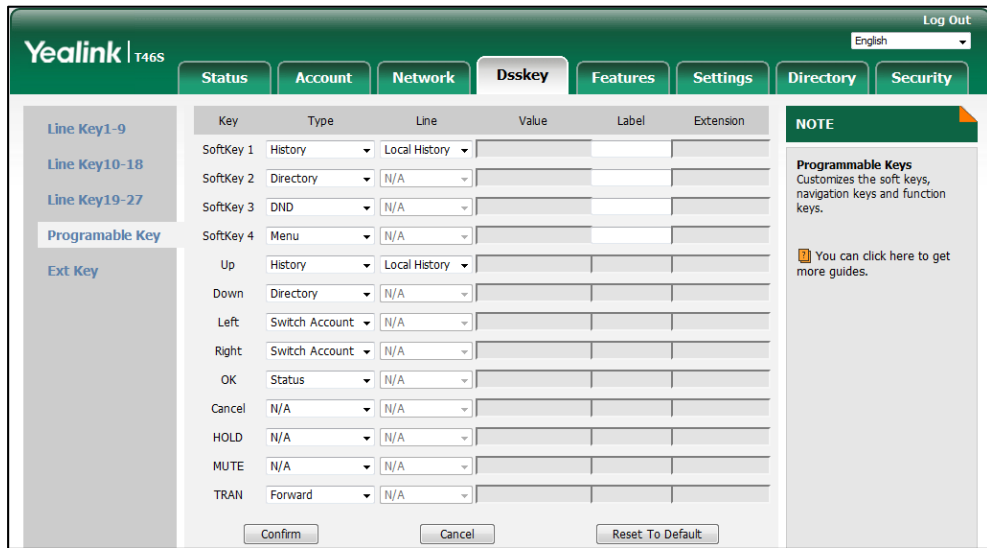

3. (Optional.) Enter the string that will appear on the LCD screen in the **Label** field.  
Label is configurable only when customizing SoftKey (1-4).
4. Click **Confirm** to accept the change.

**Note**

Programable keys are configurable via web user interface only.  
The MUTE key cannot be customized when keep mute feature is enabled. For more information, contact your system administrator.

You can click **Reset To Default** to reset custom settings to defaults.

Then you can press the keys on the phone to perform the features you configured.

For example:

**Switch Account Up**

You can use this key feature to change the default account.

**Dependencies:** *Type (Switch Account Up)*

**Usage:** Press the **Switch Account Up** key to scroll up the account list to select the desired default account.

**Switch Account Down**

You can use this key feature to change the default account.

**Dependencies:** *Type (Switch Account Down)*

**Usage:** Press the **Switch Account Down** key to scroll down the account list to select the desired default account.

## Ext Keys

If EXP40 is connected to the phone, you can customize features for ext keys.

### To customize ext keys via phone user interface:

1. Long press the desired ext key on EXP40.  
The IP phone LCD screen will enter the user setting interface of this key.
2. Customize the specific features for this key on the IP phone.
3. Press the **Save** soft key to accept the change or the **Back** soft key to cancel.

Ext keys are configurable via web user interface at the path **Dsskey->Ext Key**.

For more information, refer to [Yealink EXP40 User Guide](#).

## Account Management

You can register one or multiple accounts on the SIP-T46S IP phone. You can also configure each line key to associate with an account or configure multiple line keys to associate with an account.

### Account Registration

#### To register an account via phone user interface:

1. Press **Menu->Advanced** (default password: admin) ->**Accounts**.
2. Select the desired account and then press the **Enter** soft key.
3. Select **Enabled** from the **Activation** field.
4. Enter the desired value in **Label, Display Name, Register Name, User Name, Password** and **SIP Server1/2** field respectively. Contact your system administrator for more information.
5. If you use the outbound proxy servers, do the following:
  - 1) Press ◀ or ▶, or the **Switch** soft key to select **Enabled** from the **Outbound Status** field.
  - 2) Enter the desired value in the **Outbound Proxy1/2** and **Fallback Interval** field respectively. Contact your system administrator for more information.
6. Press the **Save** soft key to accept the change or the **Back** soft key to cancel.

You can repeat steps 2 to 6 to register more accounts.

The following figures demonstrate single or multiple accounts registered on the phone:

**Single account:**



**Multiple accounts:**



**To disable an account via phone user interface:**

1. Press **Menu**->**Advanced** (default password: admin) ->**Accounts**.
2. Select the desired account and then press the **Enter** soft key.
3. Select **Disabled** from the **Activation** field.
4. Press the **Save** soft key to accept the change or the **Back** soft key to cancel.

Registering an account is configurable via web user interface at the path **Account**->**Register**.

## Default Account

**To configure the default account via phone user interface:**

1. Press **Menu**->**Features**->**Others**->**Default Account**.

- Press  or , or the **Switch** soft key to select the desired account.



- Press the **Save** soft key to accept the change or the **Back** soft key to cancel.

Default account can be set by pressing  or  on the idle screen. It has priority when placing a call.

**Note** The phone's default account cannot be changed after reboot.

## Multiple Line Keys per Account

You can configure multiple line keys to associate with an account. This enhances call visualization and simplifies call handling.

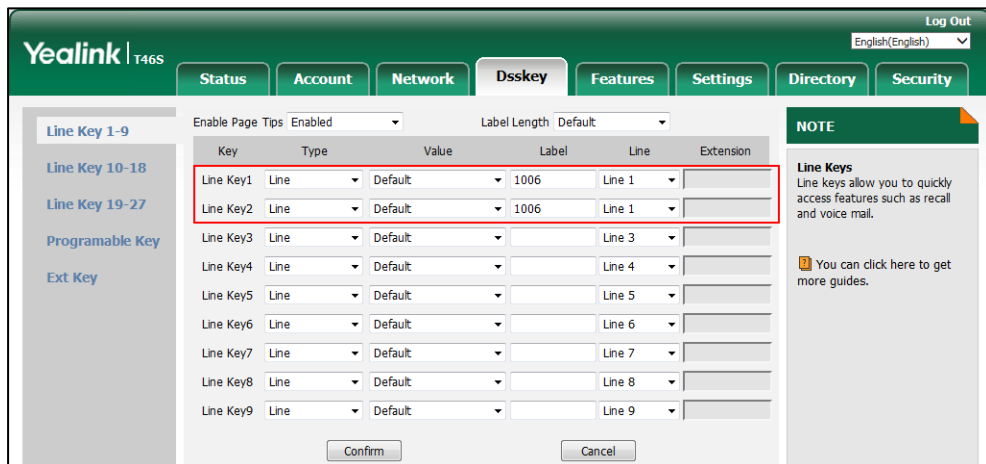

If this is the case, the LCD screen will resemble the following figure:



Incoming calls to this account will be distributed evenly among the available line keys. Outgoing calls will be distributed similarly.

Your phone can be configured to have a combination of accounts with a single line key and accounts with multiple line keys.

## Dial Plan

Dial plan is a string of characters that governs the way your SIP-T46S IP phone processes the inputs received from your phone keypad.

The SIP-T46S IP phone supports the following dial plan features:

- [Replace Rule](#)
- [Dial Now](#)
- [Area Code](#)
- [Block Out](#)

The basic expression syntax you need to know:

.	The dot "." can be used as a placeholder or multiple placeholders for any character. Example: "12." would match "123", "1234", "12345", "12abc", etc.
x	An "x" can be used as a placeholder for any character. Example: "12x" would match "121", "122", "123", "12a", etc.
-	Numeric ranges are allowed within the brackets: Digit "-" Digit. Example: "[5-7]" would match the number "5", "6" or "7".
[]	The square brackets "[]" can be used as a placeholder for a single character which matches any of a set of characters. Example: "91[5-7]1234" would match "9151234", "9161234", "9171234".
()	The parentheses "()" can be used to group together patterns, for instance, to logically combine two or more patterns. Example: "([1-9])([2-7])3" would match "923", "153", "773", etc.



\$	<p>The "\$" followed by the sequence number of a parenthesis means the characters placed in the parenthesis. The sequence number stands for the corresponding parenthesis. Example:</p> <p>A replace rule configuration, Prefix: "001(xxx)45(xx)", Replace: "9001\$145\$2". When you dial out "0012354599" on your phone, the IP phone will replace the number with "9001<b>2354599</b>". "\$1" means 3 digits in the first parenthesis, that is, "235". "\$2" means 2 digits in the second parenthesis, that is, "99".</p>
----	---

**Note** The IP phone supports a new dial plan mechanism – digit map. Digit maps are defined by a single string or a list of strings. If a number you dial matches any string of a digit map, the call is automatically placed.

Note that if digit map feature is enabled, the old dial plan rules (described in this chapter) will be ignored. For more information, contact your system administrator.

## Replace Rule

You can configure one or more replace rules (up to 100) to remove the specified string and replace it with another string. You can configure a pattern with wildcards (refer to the expression syntax in the table above), so that any string that matches the pattern will be replaced. This feature is convenient for you to dial out a long number. For example, a replace rule is configured as "Prefix: 1" and "Replace: 1234567", when you try to dial out the number "1234567", you just need to enter "1" on the phone and then press the Send soft key.

### To add a replace rule via web user interface:

1. Click on **Settings->Dial Plan->Replace Rule**.
2. Enter the string (e.g., 1) in the **Prefix** field.
3. Enter the string (e.g., 1234567) in the **Replace** field.
4. Enter the desired line ID in the **Account** field or leave it blank.

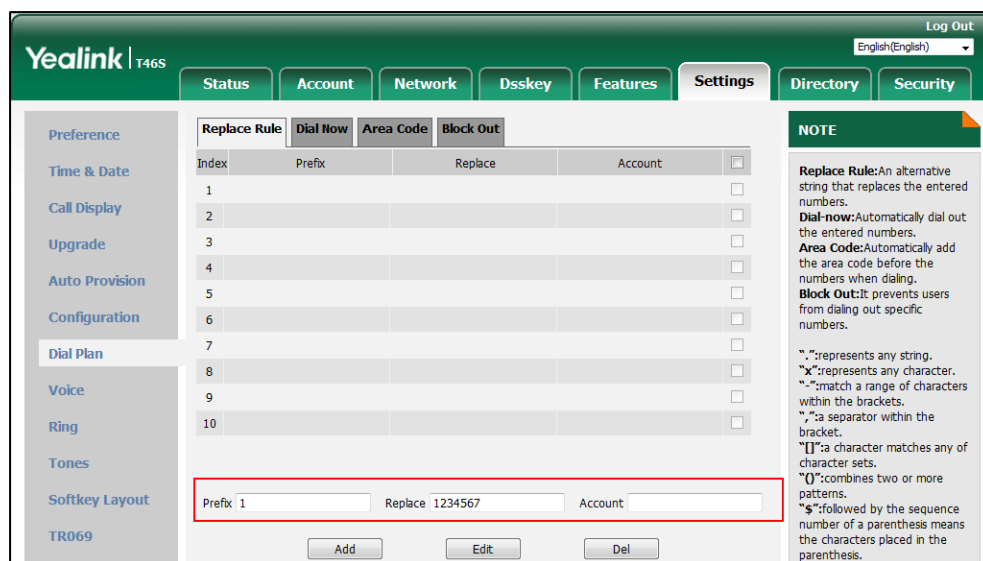

5. Click **Add** to add the replace rule.

When you enter the number "1" using the keypad and then press the **Send** soft key, the phone will dial out "1234567" instead.

**Note**

The valid values for the **Account** field can be one or more digits among 1-16. Every two digits must be separated by a comma. For example, when you enter the value "1, 2" in the **Account** field, this replace rule will apply to account 1 and account 2.

If you leave the **Account** field blank or enter 0, the replace rule will apply to all accounts.

**To edit a replace rule via web user interface:**

1. Click on **Settings->Dial Plan->Replace Rule**.
2. Select the desired replace rule by checking the checkbox.
3. Edit the values in the **Prefix** and **Replace** fields.
4. Enter the desired line ID in the **Account** field or leave it blank.
5. Click **Edit** to accept the change.

**To delete one or more replace rules via web user interface:**

1. Click on **Settings->Dial Plan->Replace Rule**.
2. Select the one or more replace rules by checking the checkbox(es).
3. Click **Del** to delete the replace rule(s).

**Note**

Replace rule is configurable via web user interface only.

## Dial Now

You can configure one or more dial now rules (up to 100) on your phone. When the dialed number matches the dial now string, the number will be dialed out automatically. For example, a dial now rule is configured as "1xxx", any entered four-digit string beginning with 1 will then be dialed out automatically on the phone.

**To add a dial now rule via web user interface:**

1. Click on **Settings->Dial Plan->Dial Now**.
2. Enter the desired value (e.g., 1xxx) in the **Rule** field.
3. Enter the desired line ID in the **Account** field or leave it blank.

For more information on the valid values for the **Account** field, refer to [Replace Rule](#) on page 107.

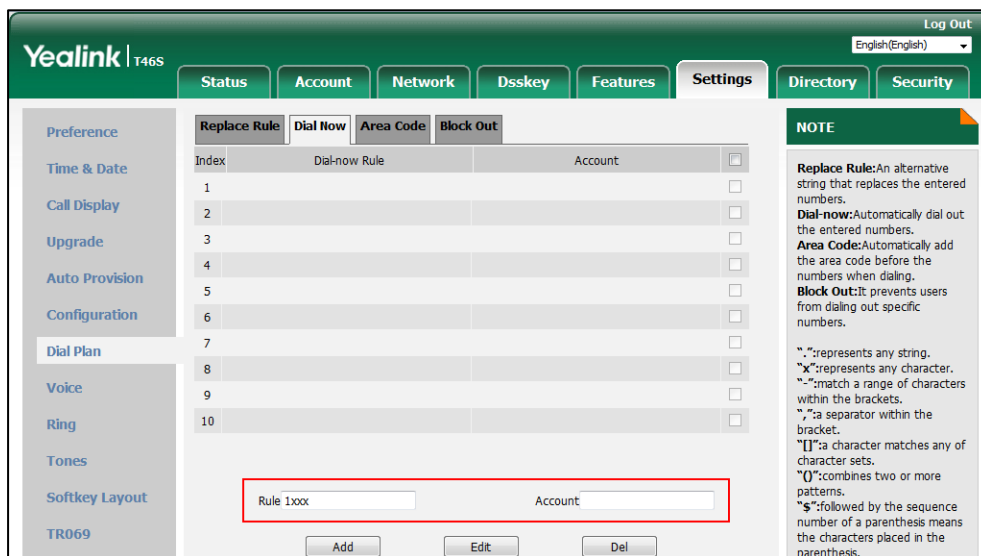

4. Click **Add** to add the dial now rule.

When you enter the number "1234" using the keypad, the phone will dial out "1234" automatically without the pressing of any key.

**Note**

You can also edit or delete the dial now rule, refer to [Replace Rule](#) on page 107 for more information.

Dial now rule is configurable via web user interface only.

**Time Out for Dial Now Rule**

You can configure the delay time for dial now rules. That is, you can configure your phone to automatically dial out the phone number which matches a dial now rule, after the designated delay time.

**To configure the delay time for dial now rule via web user interface:**

1. Click on **Features**->**General Information**.
2. Enter the time between 0 and 14 (seconds) in the **Time Out for Dial Now Rule** field.  
The default value is "1".

The screenshot shows the Yealink T46S web user interface. The 'Features' tab is selected, and the 'General Information' sub-tab is active. The 'Time Out for Dial Now Rule' field is highlighted with a red box and contains the value '1'. Other settings include Call Waiting (Enabled), Call Waiting On Code, Call Waiting Off Code, Auto Redial (Disabled), Auto Redial Interval (1~300s) (10), Auto Redial Times (1~300) (10), Key As Send (#), Reserve # in User Name (Enabled), Hotline Number, Hotline Delay (0~10s) (4), Busy Tone Delay (Seconds) (0), Return Code When Refuse (486 (Busy Here)), Return Code When DND (480 (Temporarily Unava)), Call Completion (Disabled), Feature Key Synchronization (Disabled), and RFC 2543 Hold (Disabled). A 'NOTE' section on the right provides details for Call Waiting, Auto Redial, Key As Send, Hotline, and Call Completion.

3. Click **Confirm** to accept the change.

**Note** Time out for dial now rule is configurable via web user interface only.

## Area Code

Area codes are also known as Numbering Plan Areas (NPAs). They usually indicate geographical areas in a country. This feature is necessary when dialing a phone number outside the code area. For example, an area code is configured as "Code: 0592, Min Length: 1, Max Length: 15". When you dial out the number "56789" (the length of the number is between 1 and 15), the phone will add the area code and dial out the number "059256789". You can only configure one area code rule on your phone.

**To configure the area code via web user interface:**

1. Click on **Settings**->**Dial Plan**->**Area Code**.
2. Enter the desired values in the **Code**, **Min Length (1-15)** and **Max Length (1-15)** fields.
3. Enter the desired line ID in the **Account** field or leave it blank.

For more information on the valid values for the **Account** field, refer to [Replace Rule](#) on page 107.

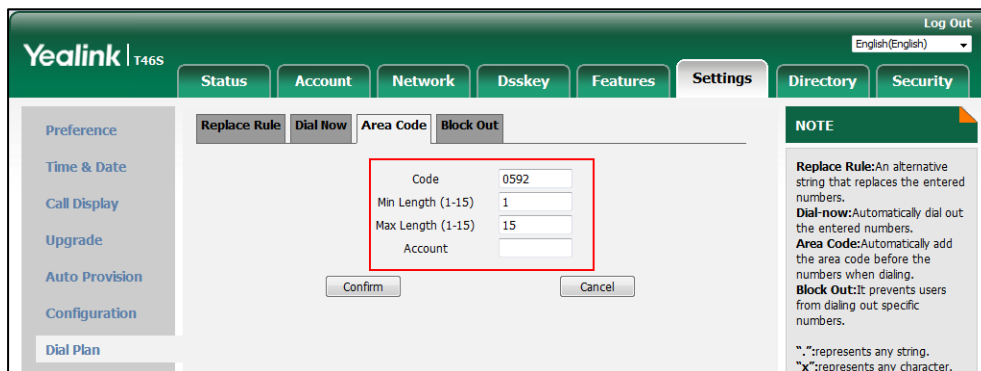

4. Click **Confirm** to accept the change.

**Note**

The default value of minimum and maximum length is 1 and 15 respectively.  
Area code is configurable via web user interface only.

## Block Out

You can block some specific numbers (up to 10) from being dialed on your phone. When you dial a block out number on your phone, the dialing will fail and the LCD screen will prompt "Forbidden Number".

**To add a block out number via web user interface:**

1. Click on **Settings->Dial Plan->Block Out**.
2. Enter the desired value in the **BlockOut NumberX** field.
3. Enter the desired line ID in the **Account** field or leave it blank.

For more information on the valid values for the **Account** field, refer to [Replace Rule](#) on page 107.

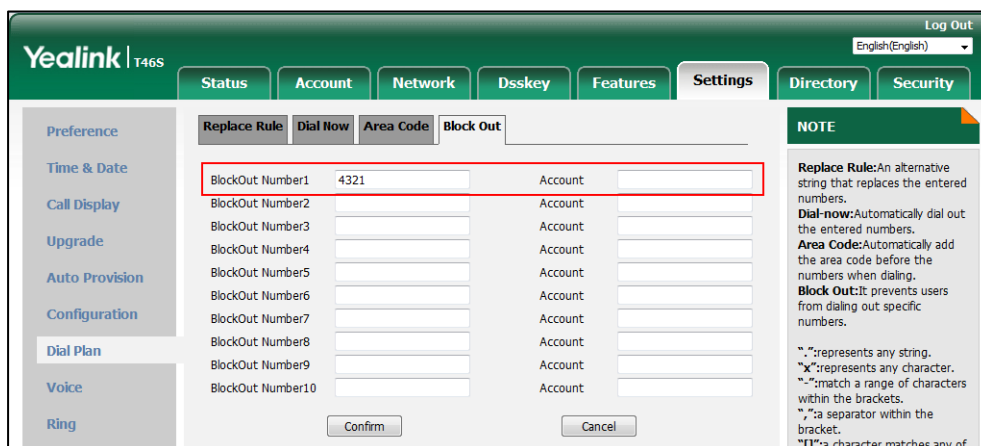

- Click **Confirm** to add the block out number.

**Note** Block out number is configurable via web user interface only.

## Emergency Number

Public telephone networks in countries around the world have a single emergency telephone number (emergency services number), that allows a caller to contact local emergency services for assistance when necessary. The emergency telephone number may differ from country to country. It is typically a three-digit number so that it can be easily remembered and dialed quickly. Some countries have a different emergency number for each of the different emergency services.

You can specify the emergency telephone numbers on the IP phone for contacting the emergency services in an emergency situation. You can dial these numbers when the phone is locked. For more information on phone lock, refer to [Phone Lock](#) on page 52.

**Note** Contact your local phone service provider for available emergency numbers in your area. The IP phone also supports the emergency dialplan, which allows users to make emergency calls if the phone is locked or unregistered. For more information, contact your system administrator.

### To specify emergency numbers via web user interface:

- Click on **Features->Phone Lock**.
- Enter the emergency number in the **Emergency** field.

For multiple emergency numbers, enter a comma between every two numbers. The default emergency numbers are 112, 911 and 110.

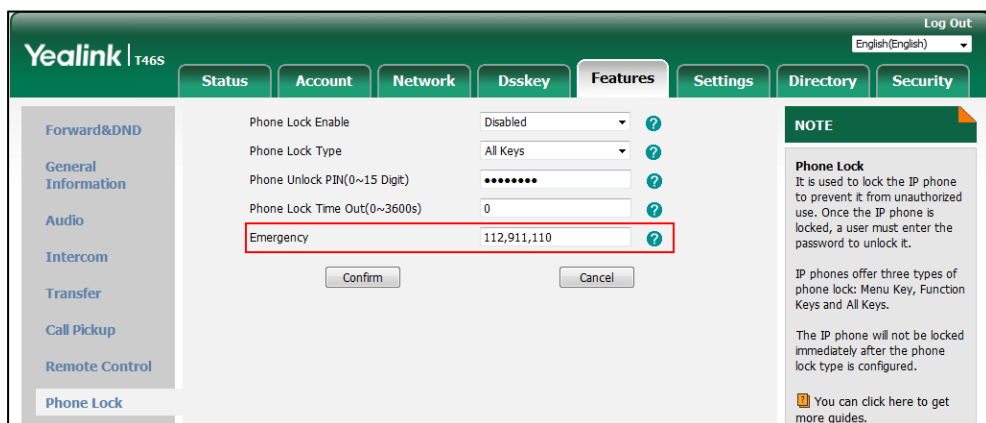

- Click **Confirm** to accept the change.

**Note** Emergency number is configurable via web user interface only.

## Live Dialpad

You can enable live dialpad feature on the SIP-T46S IP phone, which enables the IP phone to automatically dial out a phone number without pressing the send key. You can also configure a delay, and then the phone will dial out the phone number automatically after the designated period of time.

### To enable the live dialpad via web user interface:

1. Click on **Settings**->**Preference**.
2. Select **Enabled** from the pull-down list of **Live Dialpad**.
3. Enter the desired delay time in the **Inter Digit Time(1~14s)** field.  
The default delay time is 4s.

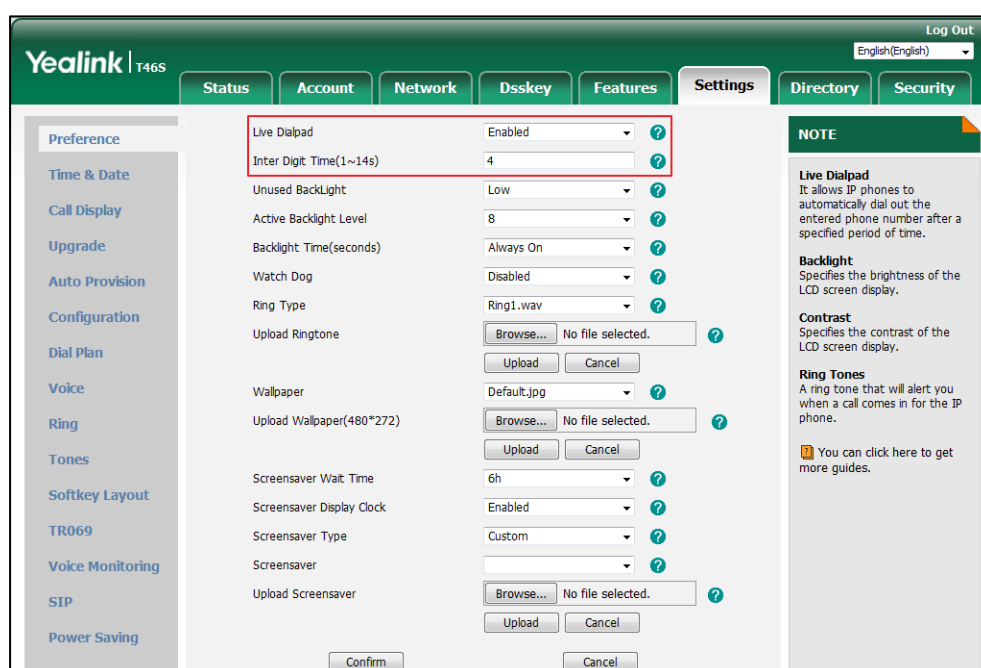

4. Click **Confirm** to accept the change.

**Note** Live dialpad is configurable via web user interface only.

## Hotline

You can dial a hotline number immediately upon lifting the handset, pressing the Speakerphone key or the line key. You can also configure a delay, and then the phone will dial out the hotline number automatically after the designated period of time.

### To configure the hotline number via phone user interface:

1. Press **Menu**->**Features**->**Others**->**Hot Line**.
2. Enter the desired number in the **Hotline Number** field.

3. Enter the delay time in the **Hotline Delay** field.

The valid values range from 0 to 10 (seconds) and the default value is "4".



Hot Line

1. Hotline Number: 1234

2. Hotline Delay: 4

Back 123 Delete Save

4. Press the **Save** soft key to accept the change or the **Back** soft key to cancel.

Hotline is configurable via web user interface at the path **Features->General Information**.



## Basic Call Features

---

The SIP-T46S IP phone is designed to be easily used like a regular phone on a public switched telephone network (PSTN). You can place calls, answer calls, transfer a call to someone else, or conduct a conference call.

This chapter provides basic operating instructions for the SIP-T46S IP phone. Topics include:

- [Placing Calls](#)
- [Answering Calls](#)
- [Ending Calls](#)
- [Redialing Numbers](#)
- [Recent Call In Dialing](#)
- [Auto Answer](#)
- [Auto Redial](#)
- [Call Completion](#)
- [ReCall](#)
- [Call Mute](#)
- [Call Hold/Resume](#)
- [Do Not Disturb \(DND\)](#)
- [Call Forward](#)
- [Call Transfer](#)
- [Call Waiting](#)
- [Conference](#)
- [Call Park/Retrieve](#)
- [Call Pickup](#)
- [Anonymous Call](#)
- [Anonymous Call Rejection](#)

If you require additional information or assistance with your new phone, contact your system administrator.

## Placing Calls

You can place a call in one of three ways using your SIP-T46S IP phone:

- Using the handset

- Using the speakerphone
- Using the headset

You can also dial the number first, and then choose the way you want to speak to the other party.



You can also search and dial a contact from call history, local directory or remote phone book. For more information, refer to [Contact Management](#) on page 59 and [Call History Management](#) on page 78.

During a call, you can alternate between Speakerphone, Headset, and Handset modes by pressing the Speakerphone key, the HEADSET key, or by picking up the handset.

The call duration of the active call and far-site's information (name or phone number) are visible on the LCD screen. In the figure below, the call to "1026" (the phone number: 1026) has lasted 15 seconds.



**To place a call using the handset:**

1. Pick up the handset.
2. Enter the desired number using the keypad.
3. Press , , or the **Send** soft key.



The # key is configured as a send key by default. You can also set the \* key as the send key, or set neither. For more information, refer to the [Key As Send](#) on page 51.

**Note**



You can also dial using the SIP URI or IP address. To obtain the IP address of a phone, press the **OK** key when the phone is idle. The maximum length of SIP URI or IP address length is 32 characters. For example, SIP URI: 3606@sip.com, IP: 192.168.1.15 (192\*168\*1\*15).  
 Your phone may not support direct IP dialing. Contact your system administrator for more information.

**To place a call using the hands-free (speakerphone) mode:**

Do one of the following:







- With the handset on-hook, press  or the line key to obtain a dial tone.  
 Enter the desired number using the keypad.  
 Press , , or the **Send** soft key.

- With the handset on-hook, enter the desired number using the keypad.

Press , ,  or the **Send** soft key.

#### To place a call using the headset:

Do one of the following:

- With the optional headset connected, press  to activate the headset mode.  
Press the line key to obtain a dial tone.  
Enter the desired number using the keypad.  
Press , , or the **Send** soft key.
- With the optional headset connected, press  to activate the headset mode.  
Enter the desired number using the keypad.  
Press , , or the **Send** soft key.





#### Note



To permanently use the headset mode, refer to [Headset Prior](#) on page 83.

The SIP-T46S IP phone can handle multiple calls at a time. However, only one active call (the call that has audio associated with it) can be in progress at any time, other calls are placed on hold. The SIP-T46S IP phone can handle a maximum of 50 calls at one time.

#### To place multiple calls:

You can have more than one call on your SIP-T46S IP phone. To place a new call during an active call, do one of the following:

- Press the line key. The active call is placed on hold.  
Enter the desired number using the keypad.  
Press , , or the **Send** soft key.
- Press  or the **Hold** soft key to place the original call on hold.  
Press the **New Call** soft key.  
Enter the desired number using the keypad.  
Press , , or the **Send** soft key.

You can press  or  to switch between calls, and then press the **Resume** soft key to retrieve the desired call.

#### Note

If multiple accounts are registered on the phone, you can first press the desired line key on the idle screen or press the **Line** soft key on the dialing screen, and then you can use the selected account to place a call.

## Answering Calls

When you are not in another call, you can answer a call in one of three ways:

- Using the handset
- Using the speakerphone
- Using the headset

### Note

You can reject incoming calls by pressing the **X** key or the **Reject** soft key. You can also activate Do Not Disturb mode to ignore the incoming calls without ringing on your phone. For more information, refer to [Do Not Disturb \(DND\)](#) on page 128.

You can forward incoming calls to someone else by pressing the **Forward** soft key. For more information, refer to [Call Forward](#) on page 132.

### Answering When Not in Another Call

Call duration and destination will always appear on the LCD screen for the active call.

#### To answer a call using the handset:

1. Pick up the handset.

#### To answer a call using the hands-free (speakerphone) mode:

Do one of the following:

- Press .
- With the handset on-hook and the headset mode deactivated, press the **Answer** soft key.
- With the handset on-hook and the headset mode deactivated, press the line key with the fast-flashing green LED indicator.

#### To answer a call using the headset:

Do one of the following:

- Press .
- With the headset mode activated, press the **Answer** soft key.
- With the headset mode activated, press the line key with the fast-flashing green LED indicator.

### Answering When in Another Call

If you have an active call, and an incoming call arrives on the phone, do one of the following:

- Press the **Answer** soft key.  
The incoming call is answered and the original call is placed on hold.
- Press  to access the new call.





Press  or the **Answer** soft key.

The incoming call is answered and the original call is placed on hold.



## Ending Calls

### To end a call:

Do one of the following:

- If you are using the handset, press , the **End Call** soft key or hang up the handset.
- If you are using the headset, press , or the **End Call** soft key.
- If you are using the speakerphone, press ,  or the **End Call** soft key.

### Note





When a call is placed on hold, you cannot press  to end it. You should press the **Resume** soft key to resume the call, and then press  to end it.

## Redialing Numbers

### To redial the last dialed number from your phone:

1. Press  twice.  
A call to your last dialed number is attempted.

### To redial a previously dialed number from your phone:

1. Press  when the phone is idle.
2. Press  or  to select the desired entry from the placed calls list, and then press  or the **Send** soft key.

## Recent Call In Dialing

To view the placed calls list when the phone is on the dialing screen, you should enable recent call in dialing in advance.

**To enable recent call in dialing via web user interface:**

1. Click on **Directory->Setting**.
2. Select **Enabled** from the pull-down list of **Recent Call In Dialing**.

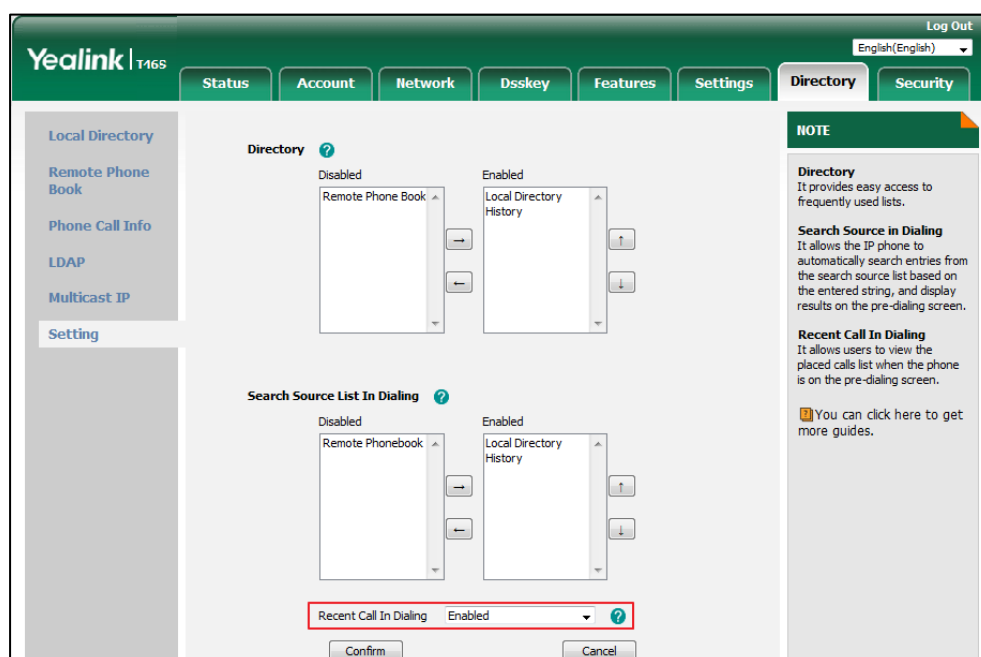

3. Click **Confirm** to accept the change.

**Note**

Recent call in dialing is configurable via web user interface only.

**To view placed calls list when the phone is on the dialing screen:**

1. Pick up the handset, press the Speakerphone key or press the line key.  
The LCD screen displays the placed calls list.



You can also enter a few continuous characters of the contact name or continuous numbers of the contact number (office, mobile or other number) to search from placed calls list.



## Auto Answer

You can use auto answer feature to automatically answer an incoming call on a line. Auto answer is configurable on a per-line basis.

You can choose to mute the local microphone when an incoming call is answered automatically. For more information, refer to [Keep Mute](#) on page 125.

### To configure auto answer via phone user interface:

1. Press **Menu**->**Features**->**Auto Answer**.
2. Select the desired line and then press the **Enter** soft key.
3. Press **◀** or **▶**, or the **Switch** soft key to select **Enabled** from the **Auto Answer** field.

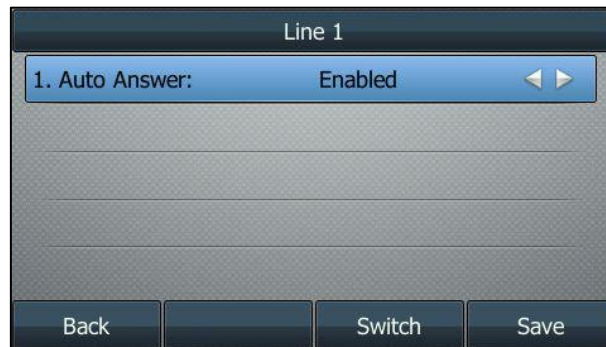

4. Press the **Save** soft key to accept the change or the **Back** soft key to cancel.

The icon **AA** appears on the LCD screen only when the auto answer feature is enabled for the default account.



Auto answer is configurable via web user interface at the path **Account->Basic**.

**Note** Auto answer only takes effect when there is no other call in progress on the phone. If there is a call in progress, the second incoming call cannot be automatically answered after ending the current call by default. If you want to make the phone automatically answer the incoming call after ending all calls, contact your system administrator for more information.

## Auto Redial

You can enable auto redial to automatically redial a phone number when the called party is busy. You can also configure the number of auto redial attempts and the time to wait between redial attempts.

### To configure auto redial via phone user interface:

1. Press **Menu->Features->Others->Auto Redial**.
2. Press **◀** or **▶**, or the **Switch** soft key to select **Enabled** from the **Auto Redial** field.
3. Enter the desired time (in seconds) in the **Redial Interval** field.  
The default value is "10".
4. Enter the desired number of redial attempts in the **Redial Times** field.  
The default value is "10".





5. Press the **Save** soft key to accept the change or the **Back** soft key to cancel.

Auto redial is configurable via web user interface at the path **Features->General Information**.

**To use auto redial:**

When the called party is busy, the following prompt will appear on the LCD screen of the phone:



1. Press the **OK** soft key to activate auto redial. The following prompt will appear on the LCD screen of the phone:





2. Wait for the designated period of time or press the **OK** soft key to redial the phone number. The phone will retry as many times as configured until the called party is idle.

## Call Completion

You can use call completion to notify the caller who failed to reach a desired party when the party becomes available to receive a call.

**To configure call completion via phone user interface:**

1. Press **Menu->Features->Others->Call Completion**.
2. Press  or  , or the **Switch** soft key to select **Enabled** from the **Call Completion** field.



3. Press the **Save** soft key to accept the change or the **Back** soft key to cancel.

Call completion is configurable via web user interface at the path **Features->General Information**.

**To use call completion:**

When the called party is busy, the following prompt will appear on the LCD screen of the phone:

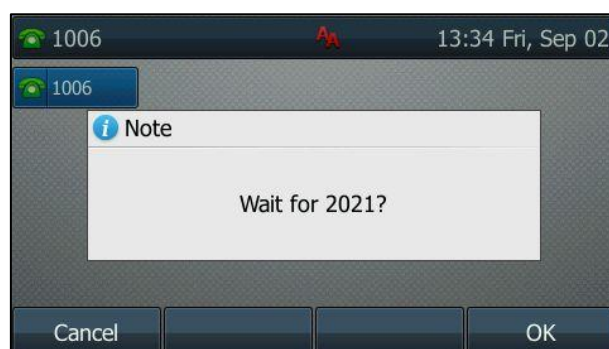

1. Press the **OK** soft key, the phone returns to the idle screen and call completion is activated.

When the called party becomes idle, the following prompt will appear on the LCD screen of the phone:



1. Press the **OK** soft key to redial the number.

**Note**

Call completion is not available on all servers. For more information, contact your system administrator.

## ReCall

You can press a recall key to place a call back to the last incoming call.

### To configure a recall key via phone user interface:

1. Press **Menu->Features->DSS Keys**.
2. Select the desired DSS key.
3. Press ◀ or ▶, or the **Switch** soft key to select **Key Event** from the **Type** field.
4. Press ◀ or ▶, or the **Switch** soft key to select **ReCall** from the **Key Type** field.
5. (Optional.) Enter the string that will appear on the LCD screen in the **Label** field.



6. Press the **Save** soft key to accept the change or the **Back** soft key to cancel.

ReCall key is configurable via web user interface at the path **Dsskey->Line key**.

## Call Mute

You can mute the microphone of the active audio device during an active call so that the other party cannot hear you. You can also mute the microphone while dialing so that the other party cannot hear you when the call is set up. It helps prevent the other party from hearing the informal discussion when auto answer is enabled on his/her phone.

Call mute applies to all modes (Handset, Headset and Speakerphone).

### Keep Mute

Normally, the mute feature is deactivated when the active call ends. Keep mute feature enables you to make the mute state of your phone persist across calls. This feature should be pre-configured by your system administrator. When keep mute is enabled and you press the MUTE key, the phone stays in the mute state until you un-mute the microphone or until the

phone restarts. It helps prevent the other party from hearing the noise coming from your room when auto answer is enabled on your phone. When you mute the phone in an idle state or any other states, the mute key LED illuminates solid red and the icon  appears on the status bar.



## Muting a Call

### To mute a call:

1. Press  during an active call.

The mute key LED illuminates solid red. The LCD screen indicates that the call is now muted.

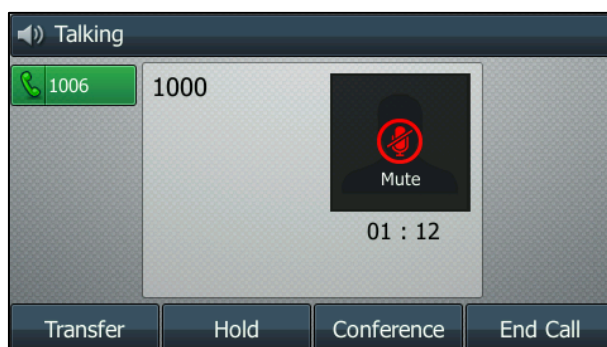

### To un-mute a call:

1. Press  again to un-mute the call.

The mute key LED goes out.

## Muting While Dialing

### To mute the microphone while dialing:

1. Press  on the pre-dialing, dialing or calling screen.

The mute key LED illuminates solid red. The call is muted automatically when setting up successfully.

**To un-mute the microphone while dialing:**

1. Press  again on the pre-dialing, dialing or calling screen.

**Note**

You can also mute the microphone when the IP phone is ringing.

## Call Hold/Resume

You can place an active call on hold. Only one active call can be in progress at any time. Other calls can be made and received while placing the original call on hold. When you place a call on hold, your IP PBX may play music to the other party while waiting.

**To place a call on hold:**

1. Press  or the **Hold** soft key during a call.

The line key LED flashes green. The LCD screen indicates that the call is on hold.

**Note**



The phone will beep softly every 30 seconds to remind you that you still have a call on hold. The phone ignores engaged audio device (handset or headset) and switches to Speakerphone to play the hold tone by default. The Speakerphone key will light up for 1 second.

**To resume a held call:**

1. Press  or the **Resume** soft key.

**Multiple Calls on Hold:**

If multiple calls are placed on hold, do one of the following:

- Press  or  to switch between the calls, and then press the **Resume** soft key to retrieve the desired call.
- Press the corresponding line key to retrieve the call.

If more than two calls are on hold, a numbered prompt appears on the LCD screen, for example "2/4", indicating that this is the second call out of four calls.

## Do Not Disturb (DND)

You can use DND to reject incoming calls automatically on the phone. The prompt message “**n New Missed Call(s)**” (“n” indicates the number of missed calls, e.g., 1 New Missed Call(s)) will appear on the LCD screen, and callers will receive a busy message. All calls you receive while DND is activated are logged to your missed calls list.



**Note** The prompt message will display only if Missed Call Log for the line is enabled. Missed call log is configurable via web user interface at the path **Account->Basic**.  
You cannot activate or deactivate DND when DND feature is disabled. Contact your system administrator for more information.

When DND feature is activated, the IP phone supports displaying a large DND icon on the idle screen. For more information, contact your system administrator.



You can activate/deactivate DND for the phone system, or you can customize DND for each or all accounts.

There are two DND modes:

- **Phone** (default): DND is effective for the phone system.
- **Custom**: DND can be configured for each or all accounts.

**To configure the DND mode via web user interface:**

1. Click on **Features->Forward&DND**.

- In the **DND** block, mark the desired radio box in the **Mode** field.

The screenshot shows the Yealink T46S web interface. The 'Features' tab is selected, and the 'Forward&DND' section is active. The 'Forward' section includes:
 

- Forward Emergency: Disabled
- Forward Authorized Numbers: [Empty field]
- Mode:  Phone  Custom
- Account: 1006

 The 'DND' section includes:
 

- DND Emergency: Disabled
- DND Authorized Numbers: [Empty field]
- Mode:  Phone  Custom (highlighted with a red box)
- Account: 1006
- DND Status:  On  Off
- DND On Code: [Empty field]
- DND Off Code: [Empty field]

 A 'NOTE' sidebar on the right provides details:
 

- Call Forward**: It allows users to redirect an incoming call to a third party.
- Call Forward Mode**:
  - Phone**: Call forward feature is effective for the IP phone.
  - Custom**: Call forward feature can be configured for each or all accounts.
- Do Not Disturb (DND)**: It allows IP phones to ignore incoming calls.
- DND Mode**:
  - Phone**: DND feature is effective for the IP phone.
  - Custom**: DND feature can be configured for each or all accounts.

 At the bottom, there are 'Confirm' and 'Cancel' buttons.

- Click **Confirm** to accept the change.

**Note** DND mode is configurable via web user interface only.

#### To activate DND in phone mode:

- Press the **DND** soft key when the phone is idle.

The icon  appears on the status bar.



**Note** When DND and busy forward are activated in phone mode, calls will be sent to the configured destination number. For more information on busy forward, refer to [Call Forward](#) on page 133.



**To activate DND in custom mode:**

1. Press the **DND** soft key when the phone is idle.

The LCD screen displays a list of accounts on the phone.



2. Press or to select the desired account, and then press the **Enter** soft key.
3. Press or , or the **Switch** soft key to select **Enabled** from the **DND Status** field.
4. (Optional.) Enter the DND on code or off code respectively in the **On Code** or **Off Code** field.

If the on code or off code is configured, the IP phone will send the corresponding code to activate or deactivate DND on the server. It is not available on all servers.

5. Press the **Save** soft key to accept the change.

If you want to activate DND for all accounts, you can press the **All On** soft key.



If you activate DND for the default account, the associated line icon will change to , and the icon will appear on the status bar.





If you activate DND for the non-default account, only the associated line icon will change to .



If you activate DND for all accounts, all line icons will change to  and the icon  will appear on the status bar.



#### Note

When DND and busy forward are both activated for a specific account, calls to the specific account will be sent to the configured destination number. For more information on call forward, refer to [Call Forward](#) on page 133.

You can receive incoming calls from authorized numbers when DND is activated.

#### To configure the DND authorized numbers via web user interface:

1. Click on **Features->Forward&DND**.
2. Select **Enabled** from the pull-down list of **DND Emergency**.
3. Enter the numbers in the **DND Authorized Numbers** field.

For multiple numbers, enter a comma between every two numbers.

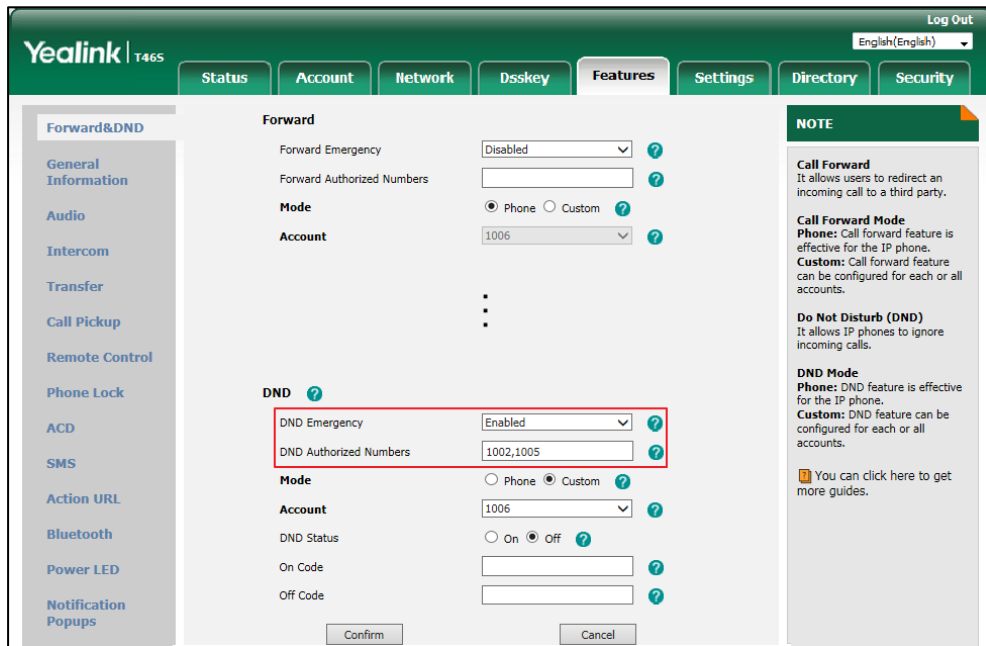

4. Click **Confirm** to accept the change.

When DND is activated on the phone, the phone can still receive incoming calls from the numbers specified in the **DND Authorized Numbers** field.

**Note**

DND authorized number is configurable via web user interface only.  
 When the phone misses a call, a prompt window will pop up by default. If you want to disable the feature, contact your system administrator for more information.

**To deactivate DND in phone mode:**

1. Press the **DND** soft key when the phone is idle.

**To deactivate DND in custom mode:**

1. Press the **DND** soft key when the phone is idle.
2. Press  $\uparrow$  or  $\downarrow$  to select the desired account and then press the **Enter** soft key.
3. Press  $\leftarrow$  or  $\rightarrow$ , or the **Switch** soft key to select **Disabled** from the **DND Status** field.
4. Press the **Save** soft key to accept the change.

If you want to deactivate DND for all accounts, press the **All Off** soft key.

## Call Forward

You can configure your phone to forward incoming calls to another party (static forwarding). You can also forward calls while your phone is ringing (dynamic forwarding).

### Note

When the phone forwards a call, a prompt window will pop up by default. If you want to disable the feature, contact your system administrator for more information.

You cannot activate or deactivate call forward when call forward feature is disabled. Contact your system administrator for more information.

## Static Forwarding

Three types of static forwarding:

- **Always Forward:** Incoming calls are immediately forwarded.
- **Busy Forward:** Incoming calls are immediately forwarded if the phone is busy.
- **No Answer Forward:** Incoming calls are forwarded if not answered after a period of time.

You can activate/deactivate call forward for the phone system, or you can customize call forward for each or all accounts.

There are two call forward modes:

- **Phone** (default): Call forward is effective for the phone system.
- **Custom:** Call forward can be configured for each or all accounts.

**To configure the call forward mode via web user interface:**

1. Click on **Features**->**Forward&DND**.

- In the **Forward** block, mark the desired radio box in the **Mode** field.

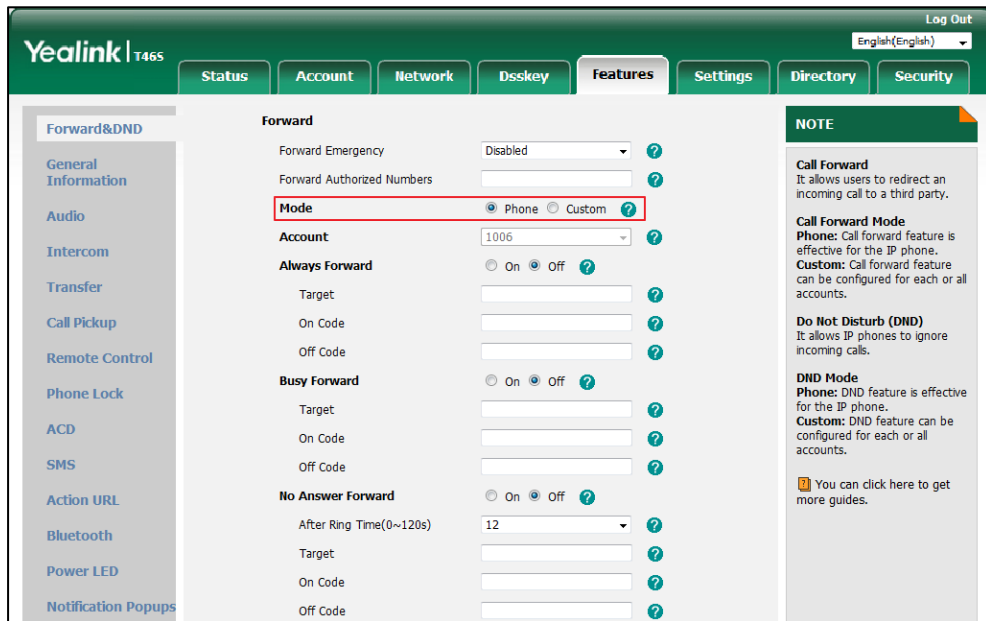

- Click **Confirm** to accept the change.

**Note** Call forward mode is configurable via web user interface only.

**To activate call forward in phone mode:**

- Press **Menu->Features->Call Forward**.
- Press **▲** or **▼** to select the desired forwarding type, and then press the **Enter** soft key.
- Depending on your selection:
  - If you select **Always Forward**:
    - Press **◀** or **▶**, or the **Switch** soft key to select **Enabled** from the **Always Forward** field.
    - Enter the destination number you want to forward all incoming calls to in the **Forward to** field.
    - (Optional.) Enter the always forward on code or off code respectively in the **On Code** or **Off Code** field.



b) If you select **Busy Forward**:

- 1) Press ◀ or ▶, or the **Switch** soft key to select **Enabled** from the **Busy Forward** field.
- 2) Enter the destination number you want to forward incoming calls to when the phone is busy in the **Forward to** field.
- 3) (Optional.) Enter the busy forward on code or off code respectively in the **On Code** or **Off Code** field.

Busy Forward			
1. Busy Forward:	Enabled ◀ ▶		
2. Forward to:	1234		
3. On Code:	*73		
4. Off Code:	*74		
Back	123	Delete	Save

c) If you select **No Answer Forward**:

- 1) Press ◀ or ▶, or the **Switch** soft key to select **Enabled** from the **No Answer Forward** field.
- 2) Enter the destination number you want to forward unanswered incoming calls to in the **Forward to** field.
- 3) Press ◀ or ▶, or the **Switch** soft key to select the ring time to wait before forwarding from the **After Ring Time** field.  
The default ring time is 12 seconds.
- 4) (Optional.) Enter the no answer forward on code or off code respectively in the **On Code** or **Off Code** field.



No Answer Forward			
1. No Answer Forward:	Enabled ◀ ▶		
2. Forward to:	1234		
3. After Ring Time:	12s ◀ ▶		
4. On Code:	*75		
5. Off Code:	*76		
Back	123	Delete	Save

4. Press the **Save** soft key to accept the change or the **Back** soft key to cancel.



The icon  on the status bar indicates that the call forward is activated.

**To activate call forward in custom mode:**



1. Press **Menu->Features->Call Forward**.

2. Press  or  to select the desired account, and then press the **Enter** soft key.





3. Press  or  to select the desired forwarding type, and then press the **Enter** soft key.
4. Depending on your selection:

a) If you select **Always Forward**, you can activate it for a specific account.

- 1) Press  or , or the **Switch** soft key to select **Enabled** from the **Always Forward** field.
- 2) Enter the destination number you want to forward all incoming calls to in the **Forward to** field.
- 3) (Optional.) Enter the always forward on code or off code respectively in the **On Code** or **Off Code** field.





You can also activate always forward for all accounts, do the following:

- 1) Press  or  to highlight the **Always Forward** field.
- 2) Press the **All Lines** soft key.

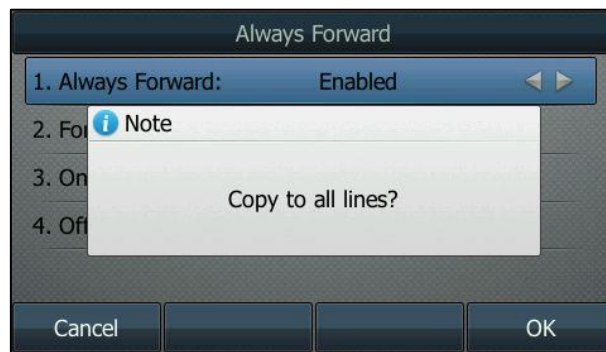

The LCD screen prompts "Copy to all lines?".



- 3) Press the **OK** soft key to accept the change or the **Cancel** soft key to cancel.
- b) If you select **Busy Forward**, you can activate it for a specific account.
- 1) Press  or , or the **Switch** soft key to select **Enabled** from the **Busy Forward** field.
  - 2) Enter the destination number you want to forward incoming calls to when the phone is busy in the **Forward to** field.
  - 3) (Optional.) Enter the busy forward on code or off code respectively in the **On Code** or **Off Code** field.



You can also activate busy forward for all accounts, do the following:

- 1) Press  or  to highlight the **Busy Forward** field.
- 2) Press the **All Lines** soft key.

The LCD screen prompts "Copy to all lines?".

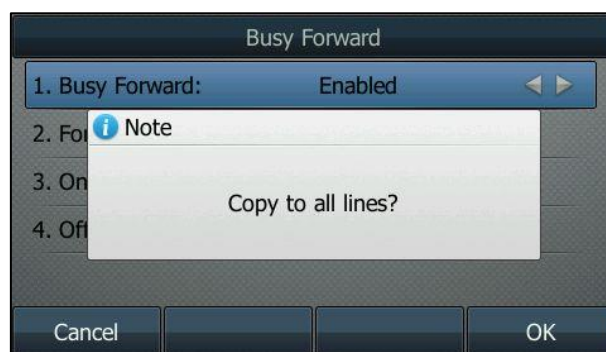



- 3) Press the **OK** soft key to accept the change or the **Cancel** soft key to cancel.
- c) If you select **No Answer Forward**, you can activate it for a specific account.
  - 1) Press ◀ or ▶, or the **Switch** soft key to select **Enabled** from the **No Answer Forward** field.
  - 2) Enter the destination number you want to forward unanswered incoming calls to in the **Forward to** field.
  - 3) Press ◀ or ▶, or the **Switch** soft key to select the ring time to wait before forwarding from the **After Ring Time** field.  
The default ring time is 12 seconds.
  - 4) (Optional.) Enter the no answer forward on code or off code respectively in the **On Code** or **Off Code** field.

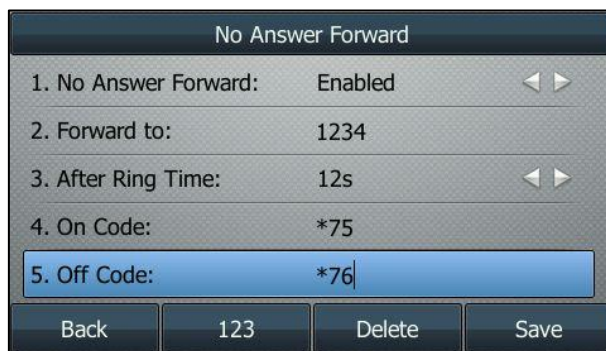

You can also activate no answer forward for all accounts, do the following:

- 1) Press ▲ or ▼ to highlight the **No Answer Forward** field.
- 2) Press the **All Lines** soft key.

The LCD screen prompts "Copy to all lines?".

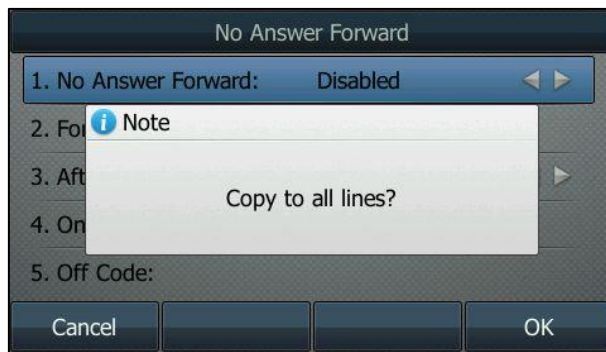

- 3) Press the **OK** soft key to accept the change or the **Cancel** soft key to cancel.
5. Press the **Save** soft key to accept the change or the **Back** soft key to cancel.



If you activate call forward for the default account, the associated line icon will change to 📞 , and the icon ↻ will appear on the status bar.

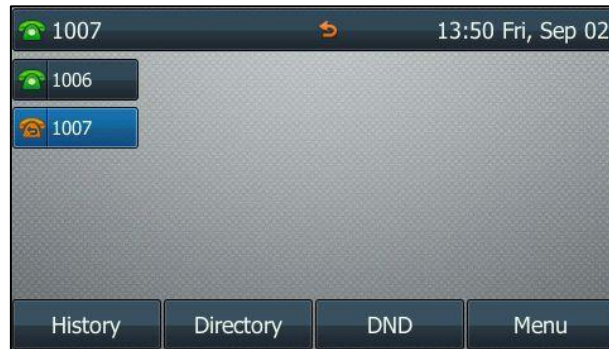

If you activate call forward for the non-default account, only the associated line icon will change to 📞 .



If you activate call forward for all accounts, all line icons will change to 📞 , and the icon ↻ will appear on the status bar.



If the forward on code or off code is configured, the IP phone sends the corresponding code to the server when a certain action takes place. For example, if you set the Always Forward on code to be \*71 (may vary on different servers), and the target number to be 1234. When you activate Always Forward on the IP phone, the IP phone sends \*711234 to the server, and then the server will activate Always Forward feature on the server side, hence being able to get the right status of the extension.

Call forward is configurable via web user interface at the path **Features->Forward&DND**.

**Note**

You can also enter the SIP URI or IP address in the **Forward to** field. For more information on using the SIP URI or IP address, refer to [Placing Calls](#) on page 115.

Call forward is local to the phone, and may be overridden by the server settings. Call forward on code or off code may be different between servers. For more information, contact your system administrator.

**To configure the forward authorized numbers via web user interface:**

1. Click on **Features->Forward&DND**.
2. Select **Enabled** from the pull-down list of **Forward Emergency**.
3. Enter the numbers in the **Forward Authorized Numbers** field.  
For multiple numbers, enter a comma between every two numbers.

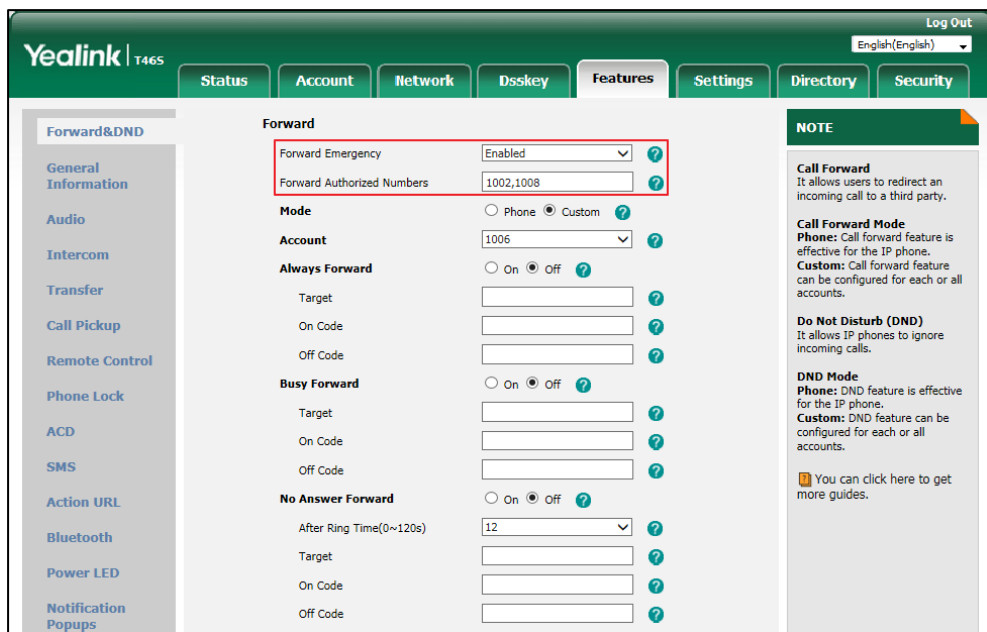

4. Click **Confirm** to accept the change.  
When call forward is activated on the phone, the phone cannot forward incoming calls from the numbers specified in the **Forward Authorized Numbers** field.





**Note**

Forward authorized number is configurable via web user interface only.







**To deactivate call forward in phone mode:**

Do one of the following:

- Press  when the phone is idle.
- Press **Menu->Features->Call Forward**.

Press  or  to select the desired forwarding type and then press the **Enter** soft key.  
 Press  or , or the **Switch** soft key to select **Disabled** to deactivate the call forward.  
 Press the **Save** soft key to accept the change.

#### To deactivate call forward in custom mode:

1. Press **Menu->Features->Call Forward** or press  when the phone is idle.
2. Press  or  to select the desired account and then press the **Enter** soft key.
3. Press  or  to select the desired forwarding type and then press the **Enter** soft key.
4. Press  or , or the **Switch** soft key to select **Disabled** to deactivate the call forward.  
 If you want to deactivate call forward for all accounts, press the **All Lines** soft key.
5. Press the **Save** soft key to accept the change.

## Dynamic Forwarding

You can manually forward a call to another number while your phone rings.

#### To forward an incoming call to another party:

1. When the phone is ringing, press the **Forward** soft key.
2. Enter the number you want to forward the incoming call to.

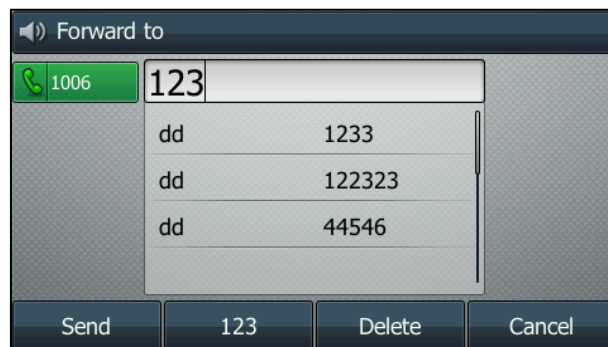

3. Press , , or the **Send** soft key.

The LCD screen prompts a call forward message.

## Call Transfer

You can transfer a call to another party during a call in one of three ways:

- **Blind Transfer:** Transfer a call directly to another party without consulting.
- **Semi-Attended Transfer:** Transfer a call when the target phone is ringing.
- **Attended Transfer (Consultative Transfer):** Transfer a call with prior consulting.

## Blind Transfer

Before performing a blind transfer (except you use dial number method), make sure that the transfer mode on DSS key is configured as **Blind Transfer**. For more information on how to configure it, refer to [Configuring Transfer Mode on DSS Key](#) on page 166.

### To perform a blind transfer during a call:

1. Press  or the **Transfer** soft key during a call.
2. You can do one of the following:
  - Enter the number you want to transfer the call to.

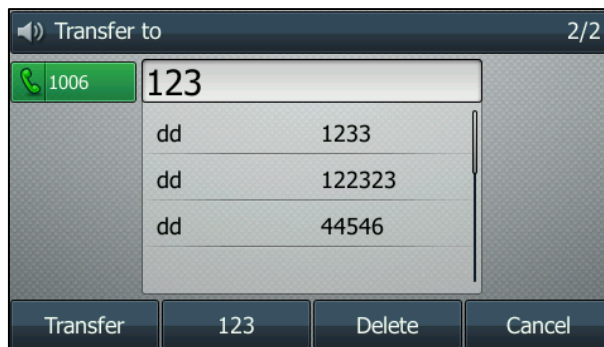





Press  or the **Transfer** soft key to complete the transfer.

If you are using a handset, the transfer can be completed by hanging up the handset.

- Press the **Directory** soft key, and then select **Local Directory**. Select the desired group and search for the contact (Directory should be configured in advance. Refer to [Directory](#) on page 59 for more information).

Press  ,  or the **Send** soft key to complete the transfer.

- Press the **Directory** soft key, and then select **History**. Select the desired list and then press  or  to select the entry (Directory should be configured in advance. Refer to [Directory](#) on page 59 for more information).

Press  ,  or the **Send** soft key to complete the transfer.

- Press the **Directory** soft key, and then select **Remote Phone Book**. Select the desired group and search for the contact (Directory should be configured in advance. Refer to [Directory](#) on page 59 and [Remote Phone Book](#) on page 76 for more information).



Press  ,  or the **Send** soft key to complete the transfer.

### To perform a blind transfer to exist call:

1. Press  or the **Transfer** soft key during a call.

- Press  or  to select the desired hold call you want to transfer the call to.















- Press ,  or the **Transfer** soft key to complete the transfer.  
Then the call is connected to the number to which you are transferring.

## Semi-attended Transfer

Before performing a semi-attended transfer (except you use dial number method), make sure that the transfer mode on DSS key is configured as **New Call** or **Attended Transfer**. For more information on how to configure it, refer to [Configuring Transfer Mode on DSS Key](#) on page 166.













### To perform a semi-attended transfer:

- Press  or the **Transfer** soft key during a call.
- Do one of the following:
  - Enter the number you want to transfer the call to.  
Press  or  to dial out.
  - Press the **Directory** soft key, and then select **Local Directory**. Select the desired group and search for the contact (Directory should be configured in advance. Refer to [Directory](#) on page 59 for more information).  
Press ,  or the **Send** soft key to dial out.
  - Press the **Directory** soft key, and then select **History**. Select the desired list and then press  or  to select the entry (Directory should be configured in advance. Refer to [Directory](#) on page 59 for more information).  
Press ,  or the **Send** soft key to dial out.
  - Press the **Directory** soft key, and then select **Remote Phone Book**. Select the desired group and search for the contact (Directory should be configured in advance. Refer to [Directory](#) on page 59 and [Remote Phone Book](#) on page 76 for more information).  
Press ,  or the **Send** soft key to dial out.
- Press  or the **Transfer** soft key to complete the transfer when receiving ringback.  
If you are using a handset, the transfer can be completed by hanging up the handset.

## Attended Transfer

Before performing an attended transfer (except you use dial number method), make sure that the transfer mode on DSS key is configured as **New Call** or **Attended Transfer**. For more information on how to configure it, refer to [Configuring Transfer Mode on DSS Key](#) on page 166.

### To perform an attended transfer:

1. Press  or the **Transfer** soft key during a call.
2. Do one of the following:
  - Enter the number you want to transfer the call to.  
Press  or  to dial out.
  - Press the **Directory** soft key, and then select **Local Directory**. Select the desired group and search for the contact (Directory should be configured in advance. Refer to [Directory](#) on page 59 for more information).  
Press ,  or the **Send** soft key to dial out.
  - Press the **Directory** soft key, and then select **History**. Select the desired list and then press  or  to select the entry (Directory should be configured in advance. Refer to [Directory](#) on page 59 for more information).  
Press ,  or the **Send** soft key to dial out.
  - Press the **Directory** soft key, and then select **Remote Phone Book**. Select the desired group and search for the contact (Directory should be configured in advance. Refer to [Directory](#) on page 59 and [Remote Phone Book](#) on page 76 for more information).  
Press ,  or the **Send** soft key to dial out.
3. After the party answers the call, press  or the **Transfer** soft key to complete the transfer.



If you are using a handset, the transfer can be completed by hanging up the handset.

You can cancel the transfer before the call is connected by pressing the **Cancel** soft key.

## Call Waiting

You can enable or disable call waiting on the phone. If call waiting is enabled, you can receive another call while there is already an active call on the phone. Otherwise, another incoming call is automatically rejected by the phone with a busy message when there is an active call on the phone. You can also enable or disable the phone to play a warning tone when receiving another call.

### To configure call waiting via phone user interface:

1. Press **Menu->Features->Call Waiting**.
2. Press  or , or the **Switch** soft key to select **Enabled** from the **Call Waiting** field.

3. Press ◀ or ▶ , or the **Switch** soft key to select **Enabled** from the **Play Tone** field.
4. (Optional.) Enter the call waiting on code or off code respectively in the **On Code** or **Off Code** field.

If on code or off code is configured, the IP phone will send the corresponding code to activate or deactivate call waiting on the server. It is not available on all servers.



5. Press the **Save** soft key to accept the change or the **Back** soft key to cancel.

Call waiting is configurable via web user interface at the path **Features->General Information**.

#### Note

If on code or off code is not configured, the call waiting may not take effect. It depends on your server. Contact your server administrator for more information.

## Conference

You can create a conference with other two parties using the phone's local conference. You can create a conference between an active call and a call on hold by pressing the Conference soft key. The SIP-T46S also supports network conference.

#### Note

Network conference is not available on all servers. For more information, contact your system administrator.

## Local Conference



The SIP-T46S IP phone supports up to 3 parties (including yourself) in a conference call. This is the default method of conference called Local Conference.

#### Note

To set up a local conference call, make sure local conference feature is enabled. For more information, contact your system administrator.



#### To set up a local conference call:

1. Place a call to the first party.





2. When the first party answers the call, press the **Conference** soft key to place a new call. The active call is placed on hold.
3. Enter the number of the second party and then press , , or the **Send** soft key.
4. When the second party answers the call, press the **Conference** soft key again to join all parties in the conference.



**To join two calls in a conference:**

1. Place two calls using two different accounts on the phone (for example, place the first call using account 1, and then place the second call using account 2).
2. Press  or  to select the call for conference and ensure that the call is active (for example, select the call on account 1).
3. Press the **Conference** soft key to join the two calls in the conference on the selected account.

**During the conference call, you can do the following actions:**

- Press  or the **Hold** soft key to place the conference on hold.
- Press the **Split** soft key to split the conference call into two individual calls on hold.
- Press the **Manage** soft key, and then press  or  to select the desired party:
  - Press the **Far Mute** soft key to mute the party. The muted party can hear everyone, but no one can hear the muted party.
  - Press the **Remove** soft key to remove the party from the conference call.
  - Press the **New Call** soft key to place a new call.
  - Press the **Back** soft key to return to the previous screen.
- Press  to mute the conference call, all other participants can hear each other, but they cannot hear you.
- Press the **End Call** soft key to drop the conference call.



## Network Conference

You can use network conference feature on the SIP-T46S IP phone to conduct a conference with multiple participants.

This feature allows you to perform the following:

- Join two calls together into a conference call.
- Invite another party into an active conference call.

To use this feature, contact your system administrator for the network conference URI in advance.

### To configure network conference via web user interface:

1. Click on **Account**->**Advanced**.
2. Select the desired account from the pull-down list of **Account**.
3. Select **Network Conference** from the pull-down list of **Conference Type**.
4. Enter the conference URI (e.g., conference@example.com) in the **Conference URI** field.

The screenshot shows the 'Advanced' settings page for a Yealink T46S account. The 'Account' dropdown is set to 'Account 1'. The 'Conference Type' dropdown is set to 'Network Conference', and the 'Conference URI' text field contains 'conference@example.com'. A red rectangular box highlights these two fields. Other settings include 'Keep Alive Type' (Default), 'Keep Alive Interval(Seconds)' (30), 'RPort' (Disabled), 'Subscribe Period(Seconds)' (1800), 'DTMF Type' (RFC2833), 'BLF DTMF Code' (empty), 'Retransmission' (Disabled), 'Subscribe Register' (Disabled), 'Subscribe for MWI' (Disabled), 'SIP Registration Retry Timer(0~1800s)' (30), 'ACD Subscribe Period(120~3600s)' (3600), and 'VQ RTPC-XR Collector port' (5060). The 'NOTE' section on the right contains the following information:

- DTMF**: It is the signal sent from the IP phone to the network, which is generated when pressing the IP phone's keypad during a call.
- Session Timer**: It allows a periodic refresh of SIP sessions through a re-INVITE request, to determine whether a SIP session is still active.
- Busy Lamp Field/BLF List**: Monitors a specific extension/a list of extensions for status changes on IP phones.
- Shared Call Appearance (SCA)/ Bridge Line Appearance (BLA)**: It allows users to share a SIP line on several IP phones. Any IP phone can be used to originate or receive calls on the shared line.
- Network Conference**: It allows multiple participants.

5. Click **Confirm** to accept the change.





### Note

Network conference is configurable via web user interface only.

### To set up a network conference call:

1. Place a call to the first party.
2. Press the **Conference** soft key to place a new call.

The active call is placed on hold.

3. Enter the number of the second party and then press  ,  , or the **Send** soft key.
4. When the second party answers the call, press the **Conference** soft key to add the second party to the conference.
5. Press the **Conference** soft key to place a new call.  
The conference is placed on hold.
6. Enter the number of the new party and then press  ,  , or the **Send** soft key.
7. When the new party answers the call, press the **Conference** soft key to add the new party to the conference.
8. Repeat steps 5 to 7 until you have added all intended parties.

The procedures to set up a network conference call on specific servers may be different from introduced above. Contact your system administrator for more information.

## Call Park/Retrieve

You can use call park feature to place a call on hold, and then retrieve the call from another phone in the system (for example, a phone in another office or conference room). You can park an active call by pressing the **Park** soft key or call park key (if configured) on the phone. If the call is parked successfully, there is a voice prompt confirming that the call was parked. You can retrieve the parked call by pressing the **Retrieve** soft key or the retrieve park key (if configured). If the parked call is not retrieved within a period of time defined by the system, the phone performing call park will receive the call back.

### Note







Call park is not available on all servers. Contact your system administrator for more information.

The IP phone supports call park feature under the following modes:

- **FAC mode:** park the call to the local extension or a desired extension through dialing the park code.
- **Transfer mode:** park the call to shared parking lot through performing a blind transfer to a call park number (call park code).

You can also configure a call park key and retrieve park key.





### To configure a call park key via phone user interface:

1. Press **Menu->Features->DSS Keys**.
2. Select the desired line key.
3. Press  or  , or the **Switch** soft key to select **Key Event** from the **Type** field.
4. Press  or  , or the **Switch** soft key to select **Call Park** from the **Key Type** field.
5. Press  or  , or the **Switch** soft key to select the desired line from the **Account ID** field.
6. (Optional.) Enter the string that will appear on the LCD screen in the **Label** field.

7. (Optional.) Enter the call park code in the **Value** field.
8. Press the **Save** soft key to accept the change or the **Back** soft key to cancel.

If the call park code is already configured for the **Park** soft key, you don't need to configure it when configuring a call park key.

**To configure a retrieve park key via phone user interface:**

1. Press **Menu->Features->DSS Keys**.
2. Select the desired line key.
3. Press  or , or the **Switch** soft key to select **Retrieve Park** from the **Type** field.
4. Press  or , or the **Switch** soft key to select the desired line from the **Account ID** field.
5. (Optional.) Enter the string that will appear on the LCD screen in the **Label** field.
6. (Optional.) Enter the park retrieve code in the **Value** field.
7. Press the **Save** soft key to accept the change or the **Back** soft key to cancel.

If the park retrieve code is already configured for the **Retrieve** soft key, you don't need to configure it when configuring a retrieve park key.

Call park key and retrieve park key are configurable via web user interface at the path **Dsskey->Line Key**.

**Note**

The call park code and park retrieve code are predefined on the system server. Contact your system administrator for more information.

## FAC Mode

**To configure call park feature in FAC mode via web user interface:**

1. Click on **Features->Call Pickup**.
2. Select **FAC** from the pull-down list of **Call Park Mode**.
3. Select **Enabled** from the pull-down list of **Call Park**.  
If **Enabled** is selected, the **Park** soft key will display on the LCD screen during a call, and the **Retrieve** soft key will display on the dialing screen.
4. (Optional.) Enter the call park code in the **Call Park Code** field.  
It is configured for the **Park** soft key. This call park code will also apply to the call park key.
5. (Optional.) Enter the park retrieve code in the **Park Retrieve Code** field.

It is configured for the **Retrieve** soft key. This park retrieve code will also apply to the retrieve park key.

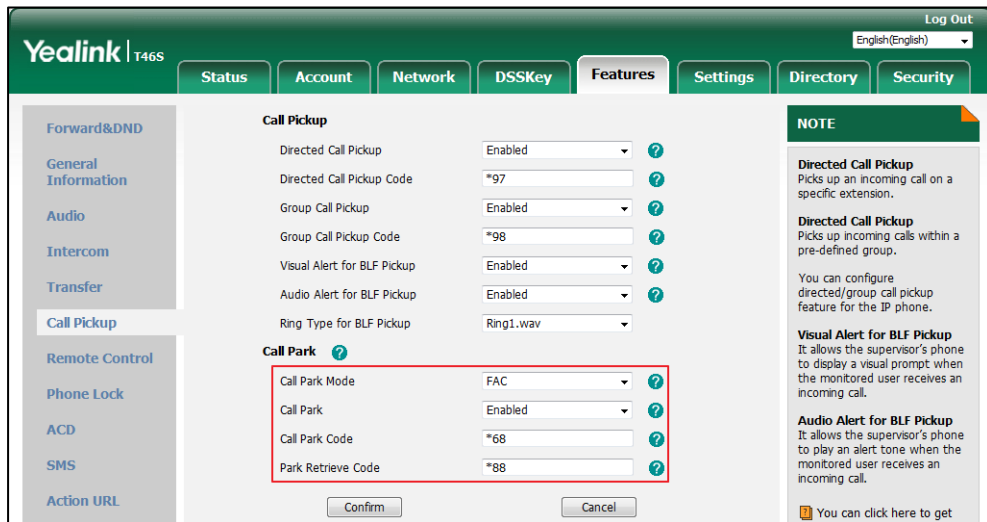



6. Click **Confirm** to accept the change.

**Note** If the **Park** or **Retrieve** soft key doesn't appear on the LCD screen, please select **Disabled** from the pull-down list of **Custom Softkey** via web user interface at path **Settings->Softkey Layout**.

**To park a call in FAC mode:**

1. During a call, press the **Park** soft key (You may need to press the **More** soft key to see the **Park** soft key) or the call park key (if configured).
  - If the call park code is not configured, you need to enter the call park code (e.g., \*68).



Press  ,  or the **Park** soft key.

- If the call park code is configured, the phone will dial the configured call park code shown as below:



2. Do one of the following:



- a) If you want to park the call against the local extension.

- 1) Press .

If the call is parked successfully, you will hear a voice prompt confirming that the call is parked.

- b) If you want to park the call against desired extension.

- 1) Enter an extension (e.g., 4605) where you want to park the call.

- 2) Press  or .

If the call is parked successfully, you will hear a voice prompt confirming that the call is parked. The call is parked against the extension you entered.

#### To retrieve a parked call in FAC mode:

1. Do one of the following:

- If the park retrieve code is not configured, dial the park retrieve code (e.g., \*88).
- If the park retrieve code is configured, press the **Retrieve** soft key on the dialing screen or retrieve park key (if configured) on the IP phone.

The phone will dial the configured park retrieve code and the Retrieve screen appears as below:



2. Follow the voice prompt, do one of the following:

- Press  on the phone where the call is parked.
- Enter the desired extension followed by # (e.g., 4605#) on any phone.

**Note** You can also press the desired BLF or BLF list key to park a call or retrieve a parked call directly. For more information, refer to [Parking a Call/Retrieving a Parked Call to the Monitored User](#) on page 168.

## Transfer Mode

**To configure call park feature in transfer mode via web user interface:**

1. Click on **Features->Call Pickup**.
2. Select **Transfer** from the pull-down list of **Call Park Mode**.
3. Select **Enabled** from the pull-down list of **Call Park**.

If **Enabled** is selected, the **Park** soft key will display on the LCD screen during a call, and the **Retrieve** soft key will display on the dialing screen.

4. (Optional.) Enter the call park code in the **Call Park Code** field.  
It is configured for the **Park** soft key. This call park code will also apply to the call park key.
5. (Optional.) Enter the park retrieve code in the **Park Retrieve Code** field.  
It is configured for the **Retrieve** soft key. This park retrieve code will also apply to the retrieve park key.

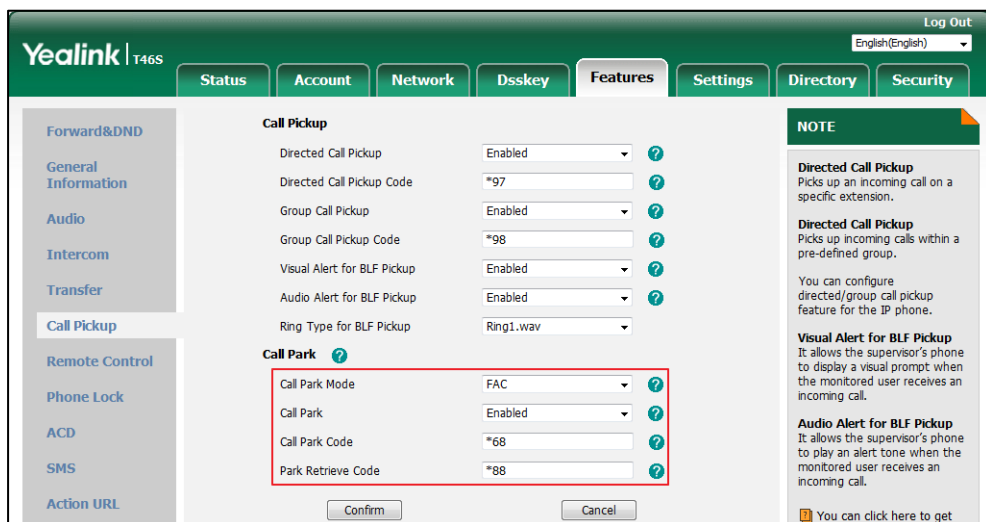



6. Click **Confirm** to accept the change.

**Note** If the **Park** or **Retrieve** soft key doesn't appear on the LCD screen, please select **Disabled** from the pull-down list of **Custom Softkey** via web user interface at path **Settings->Softkey Layout**.

**To park a call in Transfer mode:**

1. During a call, press the **Park** soft key (You may need to press the **More** soft key to see the **Park** soft key) or the call park key (if configured).
  - If the call park code is not configured, you need to enter the call park code (e.g., \*01).



Press ,  or the **Park** soft key. The call will be transferred to the shared parking lot.

- If the call park code is configured, the call will be directly transferred to the shared parking lot.

**Note**

For some servers, the system will return a specific park retrieve number (park retrieve code) from which the call can be retrieved after parking successfully.

**To retrieve a parked call in Transfer mode:**

1. Do one of the following:
  - If the park retrieve code is not configured, dial the park retrieve code (e.g., \*11).
  - If the park retrieve code is configured, press the **Retrieve** soft key on the dialing screen or retrieve park key (if configured) on the IP phone.

The phone will retrieve the parked call from the shared parking lot.

## Call Pickup

You can use call pickup to answer someone else's incoming call on your phone. The SIP-T46S IP phone supports directed call pickup and group call pickup. Directed call pickup is used for picking up a call that is ringing at a target phone number. Group call pickup is used for picking up a call that is ringing at any phone number in a certain group. The pickup group should be predefined, contact your system administrator for more information.

You can pick up an incoming call by using the **DPickup/GPickup** soft key. To use call pickup, you need to configure the call pickup code beforehand on a global or per-line basis via web user interface.

**Note** If there are many incoming calls at the same time, pressing the **GPickup** soft key on the phone will pick up the call that rings first.

## Directed Call Pickup

To enable directed call pickup and configure the directed call pickup code on a global basis via web user interface:

1. Click on **Features->Call Pickup**.
2. Select **Enabled** from the pull-down list of **Directed Call Pickup**.
3. Enter the directed call pickup code in the **Directed Call Pickup Code** field.

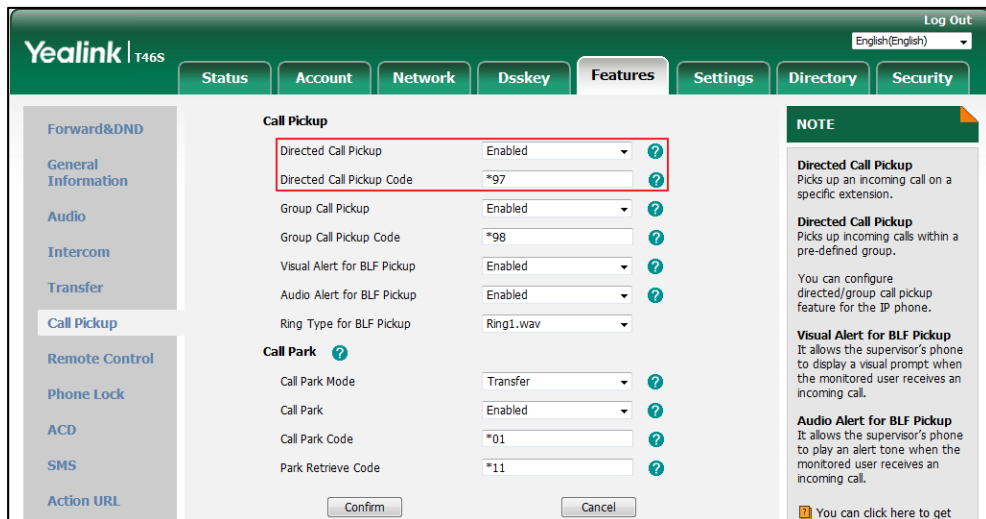

4. Click **Confirm** to accept the change.

To configure the directed call pickup code on a per-line basis via web user interface:

1. Click on **Account->Advanced**.
2. Select the desired account from the pull-down list of **Account**.



- Enter the directed call pickup code in the **Directed Call Pickup Code** field.

The screenshot shows the Yealink T46S web interface. The 'Account' tab is selected, and the 'Advanced' sub-tab is active. The 'Account' configuration page is displayed, showing various settings for 'Account 1'. The 'Directed Call Pickup Code' field is highlighted with a red box and contains the value '\*97'. Other settings include 'Keep Alive Type' (Default), 'Keep Alive Interval(Seconds)' (30), 'RPort' (Disabled), 'Subscribe Period(Seconds)' (1800), 'DTMF Type' (RFC2833), 'BLF DTMF Code' (empty), 'Group Call Pickup Code' (empty), 'Distinctive Ring Tones' (Enabled), 'Unregister When Reboot' (Disabled), 'Out Dialog BLF' (Disabled), 'VQ RTPC-XR Collector name' (empty), 'VQ RTPC-XR Collector address' (empty), and 'VQ RTPC-XR Collector port' (5060). A 'NOTE' section on the right provides information about DTMF, Session Timer, Busy Lamp Field/BLF List, Shared Call Appearance (SCA)/ Bridge Line Appearance (BLA), and Network Conference.

- Click **Confirm** to accept the change.

#### To pick up a call directly:

- Pick up the handset, press the Speakerphone key or press the line key (You may need to press the **More** soft key to see the **DPickup** soft key).

The **DPickup** soft key appears on the LCD screen.



- Press the **DPickup** soft key on your phone when the target phone receives an incoming call.
- Enter the phone number which is receiving an incoming call.
- Press the **DPickup** soft key again.

The call is answered on your phone.

You can also configure a DSS key as a direct pickup key via phone user interface or web user interface. Once configured, you can pick up a call by pressing the direct pickup key directly. For more information, refer to [DSS Keys](#) on page 89.

## Group Call Pickup

To enable group call pickup and configure the group call pickup code on a global basis via web user interface:

1. Click on **Features**->**Call Pickup**.
2. Select **Enabled** from the pull-down list of **Group Call Pickup**.
3. Enter the group call pickup code in the **Group Call Pickup Code** field.

The screenshot shows the Yealink T46S web user interface. The 'Features' tab is selected, and the 'Call Pickup' sub-tab is active. The 'Group Call Pickup' feature is set to 'Enabled', and the 'Group Call Pickup Code' is set to '\*98'. A red box highlights these two fields. The 'Call Park' section is also visible, with 'Call Park Mode' set to 'Transfer', 'Call Park' set to 'Enabled', 'Call Park Code' set to '\*01', and 'Park Retrieve Code' set to '\*11'. A 'NOTE' section on the right provides additional information about the 'Directed Call Pickup' and 'Visual Alert for BLF Pickup' features.

4. Click **Confirm** to accept the change.

To configure the group call pickup code on a per-line basis via web user interface:

1. Click on **Account**->**Advanced**.
2. Select the desired account from the pull-down list of **Account**.

- Enter the group call pickup code in the **Group Call Pickup Code** field.

The screenshot shows the Yealink T46S web interface. The 'Account' tab is selected, and the 'Group Call Pickup Code' field is highlighted with a red box, containing the value '\*98'. The interface includes a sidebar with 'Advanced' selected, a top navigation bar with 'Status', 'Account', 'Network', 'Dsskey', 'Features', 'Settings', 'Directory', and 'Security', and a 'NOTE' section on the right with various call feature descriptions.

- Click **Confirm** to accept the change.

#### To pick up a call in the group:

- Pick up the handset, press the Speakerphone key or press the line key.

The **GPickup** soft key appears on the LCD screen.



- Press the **GPickup** soft key on your phone when a phone in the group receives an incoming call.

The call is answered on your phone.

You can also configure a DSS key as a group pickup key via phone user interface or web user interface. Once configured, you can pick up a call by pressing the group pickup key directly. For more information, refer to [DSS Keys](#) on page 89.

#### Note

The direct call pickup code and group call pickup code are predefined on the system server. Contact your system administrator for more information.

The call pickup code configured on a per-line basis takes precedence over that configured on a global basis.

## Anonymous Call

You can use anonymous call to block your identify and phone number from appearing to the called party when you call someone. For example, you want to call to consult some of the services, but don't want to be harassed. Anonymous call is configurable on a per-line basis. You can also configure the phone to send anonymous call on/off code to the server to activate/deactivate anonymous call on the server side.

#### Note

Anonymous call is not available on all servers. Contact your system administrator for the anonymous call on code and off code.

#### To configure anonymous call via phone user interface:

1. Press **Menu**->**Features**->**Anonymous**.
2. Select the desired line and then press the **Enter** soft key.
3. Press  $\leftarrow$  or  $\rightarrow$ , or the **Switch** soft key to select **Enabled** from the **Local Anonymous** field.
4. (Optional.) Press  $\leftarrow$  or  $\rightarrow$ , or the **Switch** soft key to select the desired value from the **Send Anony Code** field.  
The phone will send the configured on code or off code depending on your selection when you enable or disable anonymous call feature on the phone.
5. (Optional.) Enter the anonymous call on code and off code respectively in the **On Code** and **Off Code** field.

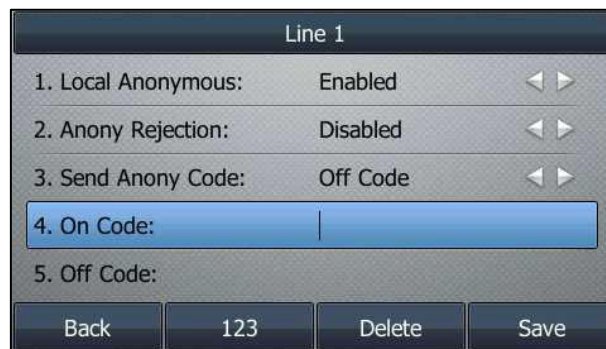

6. Press the **Save** soft key to accept the change or the **Back** soft key to cancel.

Anonymous call is configurable via web user interface at the path **Account->Basic**.

**To place an anonymous call:**

1. Using the specific line on the phone to place a call to phone B.

The LCD screen of phone B prompts an incoming call from anonymity.



## Anonymous Call Rejection

You can use anonymous call rejection to reject incoming calls from anonymous callers. Anonymous call rejection automatically rejects incoming calls from callers who deliberately block their identities and numbers from being displayed. Anonymous call rejection is configurable on a per-line basis. You can also configure the phone to send anonymous call rejection on/off code to the server to activate/deactivate anonymous call rejection on the server side.

**To configure anonymous call rejection via phone user interface:**

1. Press **Menu->Features->Anonymous**.
2. Select the desired line and then press the **Enter** soft key.
3. Press or to scroll to the **Anony Rejection** field.
4. Press or , or the **Switch** soft key to select **Enabled** from the **Anony Rejection** field.
5. (Optional.) Press or , or the **Switch** soft key to select the desired value from the **Send Rejection Code** field.

The phone will send the configured on code or off code depending on your selection when you enable or disable anonymous call rejection feature on the phone.

6. (Optional.) Enter the anonymous call rejection on code and off code respectively in the **On Code** and **Off Code** field.



7. Press the **Save** soft key to accept the change or the **Back** soft key to cancel.

Anonymous call rejection is configurable via web user interface at the path **Account->Basic**.

## Advanced Phone Features

This chapter provides operating instructions for the advanced features of the SIP-T46S IP phone. Topics include:

- [Busy Lamp Field \(BLF\)](#)
- [BLF List](#)
- [Call Recording](#)
- [Hot Desking](#)
- [Intercom](#)
- [Multicast Paging](#)
- [Music on Hold](#)
- [Automatic Call Distribution \(ACD\)](#)
- [Shared Call Appearance \(SCA\)](#)
- [Bridged Lines Appearance \(BLA\)](#)
- [Messages](#)

If you require additional information or assistance with your new phone, contact your system administrator.

### Busy Lamp Field (BLF)



You can use BLF to monitor a specific line for status changes on the phone. For example, you can configure a BLF key on the phone to monitor the status of a friend's line (busy or idle). The BLF key LED illuminates solid red when the friend's line is in use. For more information on BLF key LED indicators, refer to [LED Instructions](#) on page 9.

### Configuring the BLF Feature on the IP Phone

You need to configure the IP phone to perform BLF monitoring. IP phones being monitored do not require any configuration.

#### Configuring a BLF Key

**To configure a BLF key via phone user interface:**

1. Press **Menu->Features->DSS Keys**.
2. Select the desired DSS key.
3. Press  or  , or the **Switch** soft key to select **BLF** from the **Type** field.

4. Press ◀ or ▶, or the **Switch** soft key to select the desired line from the **Account ID** field.
5. (Optional.) Enter the string that will appear on the LCD screen in the **Label** field.
6. Enter the phone number or extension you want to monitor in the **Value** field.
7. (Optional.) Enter the directed call pickup code in the **Extension** field.

If it is configured, when the monitored user receives an incoming call, the supervisor can press the BLF key to pick up the call directly.

Line Key 3	
1. Type:	BLF
2. Account ID:	Line 1
3. Label:	1000
4. Value:	1000
5. Extension:	*33

Back    2aB    Delete    Save

8. Press the **Save** soft key to accept the change or the **Back** soft key to cancel.

BLF key is configurable via web user interface at the path **Dsskey->Line Key**.

## Configuring Visual and Audio Alert for BLF Pickup

You can enable visual alert feature for BLF pickup on the phone. This allows the LCD screen of the monitoring phone to display the caller ID when the monitored line receives an incoming call.

You can also enable audio alert feature for BLF pickup on the phone. If audio alert feature for BLF pickup is enabled, you can specify a desired ring tone to play when the monitored line receives an incoming call.

**To enable visual and audio alert features via web user interface:**

1. Click on **Features->Call Pickup**.
2. Select **Enabled** from the pull-down list of **Visual Alert for BLF Pickup**.



3. Select **Enabled** from the pull-down list of **Audio Alert for BLF Pickup**.

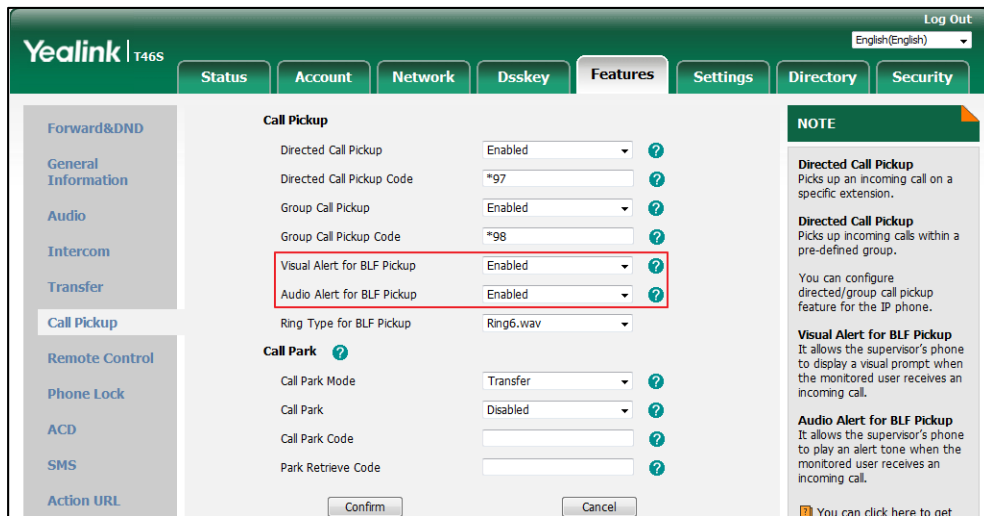

4. Click **Confirm** to accept the change.

#### Note

Visual and audio alert features are configurable via web user interface only.

#### To configure BLF ring type via phone user interface:

1. Press **Menu->Basic->Sound->BLF Ring Type**.
2. Press **▲** or **▼** to select the desired ring tone.



3. (Optional.) Press **⏪** to adjust the ringer volume.
4. Press the **Save** soft key to accept the change or the **Back** soft key to cancel.

BLF ring type is configurable via web user interface at the path **Features->Call Pickup**.

When the monitored line receives an incoming call, the following occurs on your phone:

- The phone plays a specific ring tone (if enabled).
- The BLF key LED flashes red.
- The caller ID appears on the LCD screen (if enabled).

In the following figure, the LCD screen shows an incoming call from 1008 on the monitored line.



**You can do the following actions:**

- Press the **DPickup** soft key to pick up the call.
- Press the **Send** soft key to dial out the monitored phone number.
- Press the **New Call** soft key to place a new call.
- Press the **Cancel** soft key to exit the screen.

**Note**

If your phone is locked and the type of the phone lock is configured as **Function Keys** or **All Keys**, you cannot use the **DPickup**, **Send**, **New Call** and **Cancel** soft keys until unlocked. For more information refer to [Phone Lock](#) on page 52.

## Configuring Directed Call Pickup Code

If you configure the directed call pickup code in advance, you can pick up the monitored user's incoming call by pressing the BLF key. You can configure the directed call pickup code when configuring a BLF key. For more information, refer to [Configuring a BLF Key](#) on page 161. You can also configure the directed call pickup code on a global or per-line basis via web user interface.

If you enable visual alert feature, you can also pick up the monitored user's incoming call by pressing **DPickup** soft key. To use **DPickup** soft key to pick up the call, the call pickup code can only be configured on a global or per-line basis via web user interface.

**Note**

The pickup code is used in the following order of preference: Extension (**Dsskey->Line Key**)>Directed Call Pickup Code (**Account->Advanced**)>Directed Call Pickup Code (**Features->Call Pickup**). If pickup code is not configured, pressing the BLF key/**DPickup** soft key will directly call the monitored user when he/she receives an incoming call.

**To configure the directed call pickup code on a global basis via web user interface:**

1. Click on **Features->Call Pickup**.
2. Enter the desired pickup code in the **Directed Call Pickup Code** field.

The screenshot shows the 'Call Pickup' configuration page in the Yealink T46S web interface. The 'Directed Call Pickup Code' field is highlighted with a red box and contains the value '\*97'. The page includes a sidebar with navigation options like 'Forward&DND', 'General Information', 'Audio', 'Intercom', 'Transfer', 'Call Pickup', 'Remote Control', 'Phone Lock', 'ACD', 'SMS', and 'Action URL'. The main content area has tabs for 'Status', 'Account', 'Network', 'Dsskey', 'Features', 'Settings', 'Directory', and 'Security'. The 'Features' tab is active, showing settings for 'Call Pickup' and 'Call Park'. A 'NOTE' section on the right provides details about Directed Call Pickup, Visual Alert for BLF Pickup, and Audio Alert for BLF Pickup.

3. Click **Confirm** to accept the change.

**To configure the directed call pickup code on a per-line basis via web user interface:**

1. Click on **Account->Advanced**.
2. Select the desired account from the pull-down list of **Account**.
3. Enter the desired pickup code in the **Directed Call Pickup Code** field.

The screenshot shows the 'Account' configuration page in the Yealink T46S web interface. The 'Directed Call Pickup Code' field is highlighted with a red box and contains the value '\*97'. The page includes a sidebar with navigation options like 'Register', 'Basic', 'Codec', and 'Advanced'. The main content area has tabs for 'Status', 'Account', 'Network', 'Dsskey', 'Features', 'Settings', 'Directory', and 'Security'. The 'Account' tab is active, showing settings for 'Account 1'. A 'NOTE' section on the right provides details about DTMF, Session Timer, Busy Lamp Field/BLF List, Shared Call Appearance (SCA)/ Bridge Line Appearance (BLA), and Network Conference.

4. Click **Confirm** to accept the change.

## Configuring Transfer Mode on DSS Key

When there is an active call on the IP phone, you can handle the active call differently depending on the configuration of transfer mode via Dsskey with the BLF key.

**To configure the transfer mode on DSS key via web user interface:**

1. Click on **Features->Transfer**.
2. Select the desired transfer mode from the pull-down list of **Transfer Mode via Dsskey**.
  - If you select **Blind Transfer**, press the BLF key to blind transfer the call to the monitored user.
  - If you select **Attended Transfer**, press the BLF key to dial out the monitored phone number and then perform an attended or a semi-attended transfer.
  - If you select **New Call**, press the BLF key to place a new call to the monitored user. The original call is placed on hold.

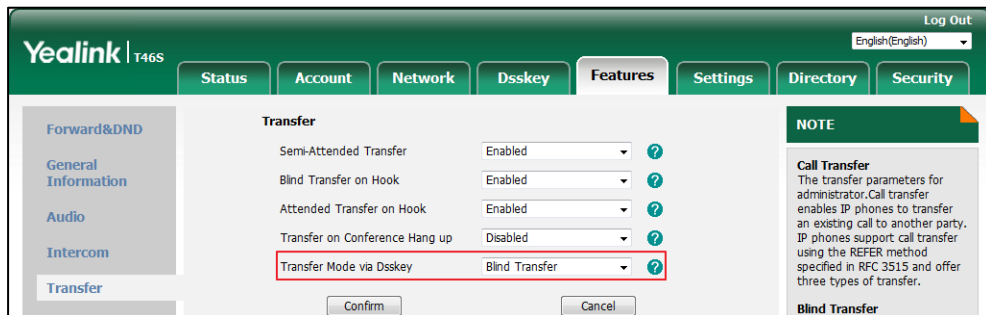

3. Click **Confirm** to accept the change.

**Note** Transfer Mode on DSS Key is also applicable to BLF list feature.

## Using BLF Feature on the IP Phone

You can use the BLF key in the following ways:

- Place a call to the monitored user.
- Transfer a call to the monitored user.
- Pick up an incoming call of the monitored user.

### Placing a Call to the Monitored User

You can press a BLF key to dial out the monitored phone number when the monitored line is idle.

**To place a call to the monitored user when the IP phone is idle:**

1. Press the BLF key.  
The IP phone dials out the phone number of the monitored user.

## Transferring a Call to the Monitored User

When there is already an active call on the IP phone, you can transfer the active call to the monitored user by pressing the BLF key. The phone handles the active call differently depending on the configuration of transfer mode via Dsskey with the BLF key (refer to [Configuring Transfer Mode on DSS Key](#)). The transfer mode on DSS key has the following modes:

- Blind Transfer
- Attended Transfer
- New Call

When the transfer mode on DSS key is set to **Blind Transfer** and there is already an active call on the IP phone, you can do the following:

### To perform a blind transfer:

1. Press the BLF key of the monitored user which you want to transfer this call to.  
Then the active call is connected to the number of the monitored user.

When the transfer mode on DSS key is set to **Attended Transfer** and there is already an active call on the IP phone, you can do the following:

### To perform a semi-attended transfer:

1. Press the BLF key of the monitored user which you want to transfer this call to. The phone will dial the number of the monitored user.
2. Press the BLF key of the monitored user again or the **Transfer** soft key to complete the transfer when receiving ringback.

### To perform an attended transfer:

1. Press the BLF key of the monitored user which you want to transfer this call to. The phone will dial the number of the monitored user.
2. Press the BLF key of the monitored user again or the **Transfer** soft key to complete the transfer after the monitored user answers the call.

When the transfer mode on DSS key is set to **New Call** and there is already an active call on the IP phone, you can do the following:

### To perform a new call:

1. Press the BLF key of the monitored user you want to call.  
The phone will dial the number of the monitored user. The original call is placed on hold.

## Picking up an Incoming Call of the Monitored User

When the monitored user receives an incoming call, the BLF key indicator of the monitored user will flash red. You can use the BLF key to pick up an incoming call of the monitored user. If you enable visual alert feature on the phone, you can pick up the incoming call using the **DPickup**

soft key. Before picking up an incoming call, ensure that the directed call pickup code has been configured in advance.

**To pick up an incoming call using the BLF key or the DPickup soft key:**

1. Press the BLF key or the **DPickup** soft key.

The incoming call of the monitored user is answered on the IP phone.

**Note**

If the call pickup code is not configured, the phone will place a call to the monitored user instead of picking up an incoming call of the monitored user when you press the BLF key or the **DPickup** soft key.

## Parking a Call/Retrieving a Parked Call to the Monitored User

You can press the desired BLF key to park a call or retrieve a parked call directly in FAC mode. It should be pre-configured by your system administrator.

**To park a call in FAC mode:**

1. During a call, press the **Park** soft key (You may need to press the **More** soft key to see the **Park** soft key).
2. Press the desired BLF key to park the call to the monitored user.

**To retrieve a parked call in FAC mode:**

1. Press the **Retrieve** soft key on the dialing screen.
2. Press the desired BLF key to retrieve a call that is parked to the monitored user.

**Note**

Make sure that the call park code/park retrieve code is configured via web user interface at the path: **Feature->Call Pickup**. For more information, refer to [FAC Mode](#) on page 149.

## BLF List

You can use the BLF List feature to monitor a list of users defined by your system administrator. For example, your system administrator enables BLF List, and creates a BLF List URI (e.g., BLFList@example.com) including a list of user1, user2 on the server. The BLF List keys on the IP phone can present the status of user1 and user2. The key LEDs illuminate either flashing or solid depending on the status of those users. For more BLF List key LED indicators, refer to [LED Instructions](#) on page 9.

You can use the BLF List keys in the following ways:

- When the monitored user is idle, press the BLF list key to dial out the phone number.
- When there is already an active call on the IP phone, you can transfer the active call to the monitored user by pressing the BLF List key. The phone handles the active call differently depending on the configuration of transfer mode via Dsskey with the BLF list key. For more

information on the transfer mode on DSS key, refer to [Configuring Transfer Mode on DSS Key](#) on page 164.

- When the monitored user receives an incoming call, press the BLF list key to pick up the call directly. Before picking up an incoming call, ensure that the BLF List Pickup Code has been configured in advance. If the code is not configured, the phone will place a call to the monitored user instead of picking up the incoming call of the monitored user when you press the BLF List key.
- When there is a conversation on the monitored user, press the BLF list key to barge in and set up a conference call. Before barging in an active call, ensure that the BLF List Barge In Code has been configured in advance. If the code is not configured, the phone will place a call to the monitored user instead of barging in an active call of the monitored user when you press the BLF List key.
- When a call is being parked against the monitored phone, press the BLF List key to retrieve the parked call from the monitored user. Before retrieving the parked call, ensure that the BLF List Retrieve Call Parked Code has been configured in advance. If the code is not configured, the phone will place a call to the monitored user instead of retrieving the parked call when you press the BLF List key.

#### To configure BLF List settings via web user interface:

1. Click on **Account->Advanced**.
2. Select the desired account from the pull-down list of **Account**.
3. Enter the BLF List URI in the **BLF List URI** field.
4. (Optional.) Enter the directed call pickup code in the **BLF List Pickup Code** field.
5. (Optional.) Enter the barge-in code in the **BLF List Barge In Code** field.
6. (Optional.) Enter the park retrieve code in the **BLF List Retrieve Call Parked Code** field.

The screenshot shows the Yealink T46S web user interface. The 'Account' tab is selected, and the 'Advanced' sub-tab is active. The 'BLF List URI' field is highlighted with a red box. The 'BLF List Pickup Code' field is set to \*97, 'BLF List Barge In Code' is \*33, and 'BLF List Retrieve Call Parked Code' is \*88. A 'NOTE' section on the right provides details about DTMF, Session Timer, Busy Lamp Field/BLF List, Shared Call Appearance (SCA)/ Bridge Line Appearance (BLA), and Network Conference.

Field	Value
Account	Account 1
Keep Alive Type	Default
Keep Alive Interval(Seconds)	30
RPort	Disabled
Subscribe Period(Seconds)	1800
DTMF Type	RFC2833
BLF DTMF Code	
PTime(ms)	20
BLF List URI	4609@pbx.yealink.com
BLF List Pickup Code	*97
BLF List Barge In Code	*33
BLF List Retrieve Call Parked Code	*88
Shared Line	Disabled
VQ RTPC-XR Collector address	
VQ RTPC-XR Collector port	5060

**NOTE**

**DTMF**  
It is the signal sent from the IP phone to the network, which is generated when pressing the IP phone's keypad during a call.

**Session Timer**  
It allows a periodic refresh of SIP sessions through a re-INVITE request, to determine whether a SIP session is still active.

**Busy Lamp Field/BLF List**  
Monitors a specific extension/a list of extensions for status changes on IP phones.

**Shared Call Appearance (SCA)/ Bridge Line Appearance (BLA)**  
It allows users to share a SIP line on several IP phones. Any IP phone can be used to originate or receive calls on the shared line.

**Network Conference**  
It allows multiple participants

7. Click **Confirm** to accept the change.

**Note**

For more information on BLF List URI/BLF List Pickup Code/BLF List Barge In Code/BLF List Retrieve Call Parked Code, contact your system administrator.

According to the response message from the server, the IP phone will automatically configure the BLF List keys beginning from the first unused DSS key (The default order of BLF list keys assigned automatically is Line Key->Ext Key. To customize the assignment order, contact your system administrator.). Once any DSS key is seized, the IP phone will skip to configure the next DSS key.

You can receive a visual or/and an audio alert (if enabled) on your phone when the monitored user receives an incoming call. For more information, refer to [Configuring Visual and Audio Alert for BLF Pickup](#) on page 162.

**Note**

The pickup code is used in the following order of preference: BLF List Pickup Code (**Account->Advanced**)>Directed Call Pickup Code (**Account->Advanced**)>Directed Call Pickup Code (**Features->Call Pickup**). If all of them are not configured, pressing the BLF List key will directly call the monitored user when he/she receives an incoming call. For more information on pickup code, refer to [Call Pickup](#) on page 153.

## Call Recording

The SIP-T46S IP phone supports local and server recording. If you insert a USB flash drive into the USB port on your phone, you can record active calls on your phone. The recordings are saved as \*.wav files on your USB flash drive. You can also record active calls by pressing a record key on the phone (refer to [Recording Using a Record Key](#)). The recordings are saved on the server.

**Note**

Before recording any call, especially those involving PSTN, it is necessary to know about the rules and restrictions of any governing call-recording in the place you are in. It is also very important to have the consent of the person you are calling before recording the conversation.



## Recording Using a USB Flash Drive

When the phone is idle, and you insert a USB flash drive into the USB port on IP phone, the phone will detect the USB flash drive and display a flashing icon . After detecting the USB flash drive, the icon stops flashing and LCD screen prompts "USB device has been connected successfully!".



When there is an active call, and you insert a USB flash drive into the USB port on your phone, the LCD screen will prompt "USB device has been connected successfully! Available Recording Time: XX:XX:XX". For more information on the available recording time, refer to [Viewing the Storage Space](#) on page 176.

The following figure shows an example:



**Note** Recording using a USB flash drive is not available by default. For more information, contact your system administrator.

### The Start REC soft key controls the recording function, and is available:

- The free space of USB flash drive is sufficient
- When there are one or more calls connected to your IP phone
- During an active call
- When calls are on hold or muted
- During an attended transfer
- During a conference call

**The Start REC soft key is not available when:**

- You place a new call
- No free space of USB flash drive
- The phone prompts you to answer an incoming call

## Call Recording

You can record active calls or conferences.

**To record a call:**

1. Press the **More** soft key, and then press the **Start REC** soft key during a call.

The LCD screen displays the icon  and recording duration.



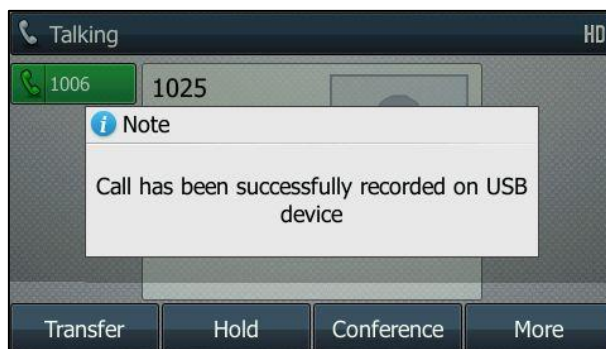

**During the recording, you can do the following:**

- Press the **More** soft key, and then press the **Pause REC** soft key. Then  appears on the LCD screen and the duration stops counting. The **Resume REC** soft key appears on the LCD screen. Both you and other parties are not recorded.  
Press the **Resume REC** soft key to continue recording.
- Press the **More** soft key, and then press the **Stop REC** soft key. The **Start REC** soft key appears on the LCD screen. Recording stops and the LCD screen prompts "Call has been successfully recorded on USB device".



Press the **Start REC** soft key to start recording again, the recording will be saved in a new ".wav" file.

- Press  or the **Hold** soft key while recording, recording is paused. Then  appears on the LCD screen and the duration stops counting. Both you and the callee are not recorded.

Press the **Resume** soft key to resume the call, the recording is continued.

- Press  while recording, the muted party is not recorded.
- If there is insufficient free space (30 minutes left) on the USB flash drive during recording, the LCD screen prompts the following:

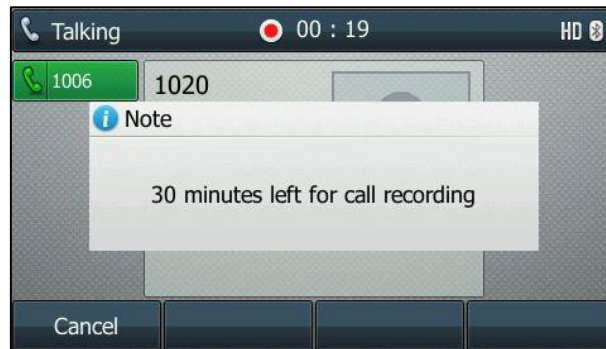

Press the **Cancel** soft key to return to the previous screen.

- If there is insufficient free space (10 minutes left) on the USB flash drive during recording, the LCD screen prompts the following:

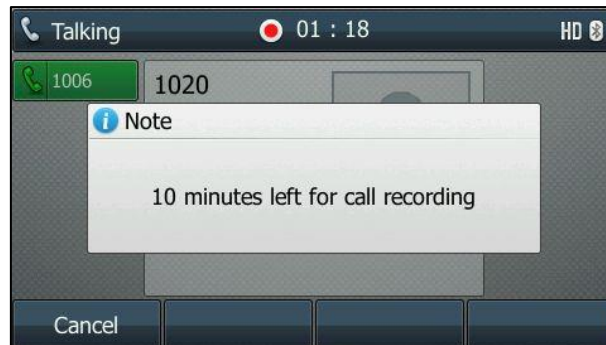

Press the **Cancel** soft key to return to the previous screen.

If no free space of the USB flash drive during recording, recording is stopped and saved on the USB flash drive automatically. The record soft keys disappear. You cannot record a call unless the space of your USB flash drive is released.

#### Note

You can transfer or set up a conference call while recording. All the calls are recorded in the same way and will be saved in as a ".wav" file.

When you end a call while recording, the recording will be stopped and saved as \*.wav files on the USB flash drive automatically.

**To stop recording while the phone records, do one of the following:**

- Press the **More** soft key, and then press the **Stop REC** soft key.

The LCD screen prompts "Call has been successfully recorded on USB device", the recording icon and recording duration disappear.

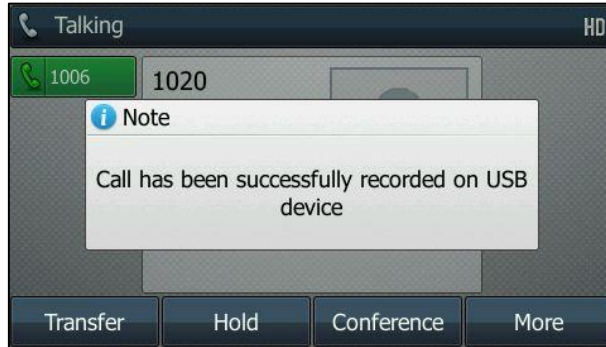

- Press the **More** soft key and then press the **End Call** soft key.

The LCD screen prompts "Call has been successfully recorded on USB device", the recording icon and recording duration disappear, and the phone returns to the idle screen.

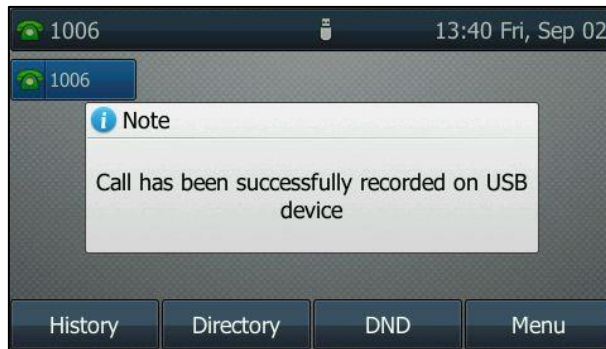

**Note** Unplugging the USB flash drive during a recording call will stop call recording, the recording will be saved on the USB flash drive automatically.

## Playing Back Recorded Calls

You can play back recorded calls on your phone. You can also browse and delete the recorded files on the USB flash drive.



**Note** Playback can occur on either the phone itself or on a computer using an application capable of playing ".wav" files.

**To browse the recorded files:**

1. Press **Menu->USB->Browse Audio**.

The LCD screen shows all recorded files on the USB flash drive. The filename consists of the recording time & date, the other party's number/IP address/name (or the first person's number/IP address/name you called).



2. Press  or  to scroll through the recorded files.
3. Press the **Play** soft key.





**During the recording playback, you can do the following:**

- Press the **Pause** soft key to pause the playback. The **Play** soft key appears on the LCD screen.  
Press the **Play** soft key to continue the playback.
- Press the **Fast Forward** soft key to skip forward the playback. Press once to skip forward 8 seconds.
- Press the **Fast Rewind** soft key to rewind the playback. Press once to rewind 8 seconds.
- Press  to adjust the volume of audio output.
- Press the **Back** soft key to stop the playback. The phone returns to the Browse Audio screen.
- Press the Speakerphone key, the HEADSET key, or pickup the handset to alternate among Speakerphone, Headset and Handset modes.

If you are playing back a recorded call and an incoming call arrives on your phone, the playback pauses and the phone rings. You can press the **Play** soft key again to play the recording when ending the call.

## Deleting the Recorded File

**To delete a recorded file:**

1. Press **Menu->USB->Browse Audio**.
2. Press  or  to highlight the recording you want to delete.
3. Press the **Delete** soft key.

The LCD screen prompts the following warning:

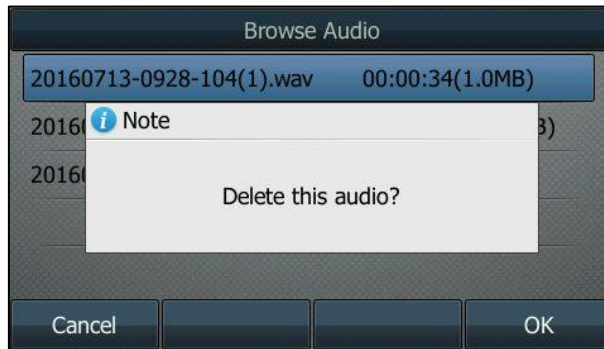

4. Press the **OK** soft key to confirm the deletion or the **Cancel** soft key to cancel.

## Viewing the Storage Space

You can view the storage space (e.g., total space, used space, free space) of the USB flash drive on the phone.

**To view the storage space:**

1. Press **Menu->USB->Storage Space**.

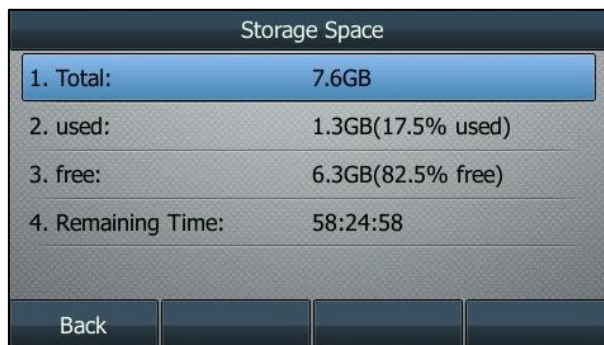

## Recording Using a Record Key

There are two ways of call recording in server:

- **Record:** The phone sends SIP INFO message containing a specific header "Record: on/off" to trigger a recording.

- **URL Record:** The phone sends HTTP URL request to trigger a recording. Contact your system administrator for the predefined URL.

**Note**

Server recording is not available on all servers. Contact your system administrator for more information.

**The Record and URL Record keys control the recording function, and are available:**





- During an active call
- When calls are on hold or muted
- During a blind or attended transfer
- During a conference call
- When the phone prompts you to answer an incoming call

**The Record and URL Record keys are not available when:**

- There are not connected calls on your phone
- You place a new call

## Configuring a Record Key

**To configure a record key via phone user interface:**

1. Press **Menu->Features->DSS Keys**.
2. Select the desired DSS key.
3. Press  or , or the **Switch** soft key to select **Key Event** from the **Type** field.
4. Press  or , or the **Switch** soft key to select **Record** from the **Key Type** field.
5. (Optional.) Enter the string that will appear on the LCD screen in the **Label** field.





6. Press the **Save** soft key to accept the change or the **Back** soft key to cancel.

Record key is configurable via web user interface at the path **Dsskey->Line Key**.



## Configuring a URL Record Key

To configure a URL record key via phone user interface:

1. Press **Menu**->**Features**->**DSS Keys**.
2. Select the desired DSS key.
3. Press  or , or the **Switch** soft key to select **URL Record** from the **Type** field.
4. (Optional.) Enter the string that will appear on the LCD screen in the **Label** field.
5. Enter the URL (e.g., http://10.1.2.224/phonerecording.cgi) in the **URL Record** field.



6. Press the **Save** soft key to accept the change or the **Back** soft key to cancel.





URL record key is configurable via web user interface at the path **Dsskey**->**Line Key**.

## Recording a Call

To record a call:

1. Press the record key or URL record key during a call.  
If the recording starts successfully, the recording icon will appear on the LCD screen and the record key or URL record key LED will flash green.
2. Press the Record or URL Record key again to stop recording.  
The recording icon disappears from the LCD screen and the record key or URL record key LED goes out.

Recording status indicators you need to know:

Circumstance	Icons on the LCD screen
A recording is started	 appears on the LCD screen
A recording cannot be started	 appears for 1 second
A recording cannot be stopped	 appears for 1 second, then goes back
The recording box is full	 appears for 1 second
The call cannot be recorded	 appears for 1 second



You can listen to the recordings saved on your server system. For example, you can dial an access code to listen to the recordings.

**Note**

The way in which you listen to the recordings may be different depending on the server. Contact your system administrator for more information.

## Hot Desking





Hot desking originates from the definition of being the temporary physical occupant of a work station or surface by a particular employee. A primary motivation for hot desking is cost reduction. This feature is regularly used in places where not all the employees are in the office at the same time, or not in the office for very long, which means that actual personal offices would be often vacant, consuming valuable space and resources.

You can use hot desking on the SIP-T46S IP phone to log out of existing accounts and then log into a new account. As a result, many users can share the phone resource at different times. To use this feature, you need to configure a hot desking key in advance.

**Note**

Hot desking is not available on all servers. Contact your system administrator for more information.

### To configure a hot desking key via phone user interface:

1. Press **Menu->Features->DSS Keys**.
2. Select the desired DSS key.
3. Press  or , or the **Switch** soft key to select **Key Event** from the **Type** field.
4. Press  or , or the **Switch** soft key to select **Hot Desking** from the **Key Type** field.
5. (Optional.) Enter the string that will appear on the LCD screen in the **Label** field.



6. Press the **Save** soft key to accept the change or the **Back** soft key to cancel.

Hot desking key is configurable via web user interface at the path **Dsskey->Line Key**.

**To use hot desking:**

1. Press the hot desking key when the phone is idle.

The LCD screen prompts the following warning:

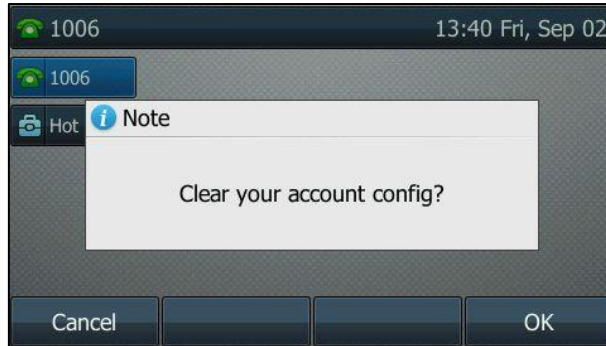

2. Press the **OK** soft key, registration configurations of all accounts on the phone will be cleared immediately.

The login wizard will be displayed as below:



3. Enter the login information in each field.
4. Press the **Save** soft key to login or the **Back** soft key to cancel.

## Intercom

Intercom is a useful feature in an office environment to quickly connect with the operator or the secretary. You can press the intercom key to automatically connect with a preconfigured target extension for outgoing intercom calls, and the target extension will automatically answer incoming intercom calls by default. You can also use intercom key to monitor a specific line for status changes on the phone.



**Note**

Intercom is not available on all servers. Contact your system administrator for more information.

## Configuring the Intercom Feature on the IP Phone

### Configuring an Intercom Key

To configure an intercom key via phone user interface:

1. Press **Menu**->**Features**->**DSS Keys**.
2. Select the desired DSS key.
3. Press  or , or the **Switch** soft key to select **Intercom** from the **Type** field.
4. Select the desired line from the **Account ID** field.
5. (Optional.) Enter the string that will appear on the LCD screen in the **Label** field.
6. Enter the target extension number in the **Value** field.
7. (Optional.) Enter the directed call pickup code in the **Extension** field.

If it is configured, when the target extension receives an incoming call, the supervisor can press the intercom key to pick up the call directly. Contact your system administrator for more information.

8. Press the **Save** soft key to accept the change or the **Back** soft key to cancel.



Line Key 3	
1. Type:	Intercom
2. Account ID:	Line 1
3. Label:	
4. Value:	1000
5. Extension:	*20*
Back	123
Delete	Save

Intercom key is configurable via web user interface at the path **Dsskey**->**Line Key**.

### Incoming Intercom Calls

The SIP-T46S IP phone supports automatically to answer an incoming intercom call by default. The phone automatically plays a warning tone when it receives an incoming intercom call. In addition, you can enable the phone to mute the microphone when it automatically answers an incoming intercom call. You can also enable the phone to automatically answer an incoming intercom call while there is already an active call on the phone. The active call is then placed on hold.

Intercom features you need to know:

Intercom Feature	Description
Intercom Allow	Enable or disable the IP phone to automatically answer an incoming intercom call.
Intercom Mute	Enable or disable the IP phone's microphone for intercom

Intercom Feature	Description
	calls.
Intercom Tone	Enable or disable the IP phone to play a warning tone when it receives an incoming intercom call.
Intercom Barge	Enable or disable the IP phone to automatically answer an incoming intercom call while there is already an active call on the phone.

### Intercom Allow

You can enable or disable the phone to automatically answer an incoming intercom call. If Intercom Allow is enabled, the phone will automatically answer an incoming intercom call. If Intercom Allow is disabled, the phone will handle an incoming intercom call like a normal call instead of directly rejecting it. Intercom Allow is enabled by default.

#### Note

Your administrator can set a period of delay time before the phone automatically answers intercom calls. Contact your system administrator for more information.

### Intercom Mute

You can mute or un-mute the phone's microphone for intercom calls automatically. If Intercom Mute is enabled, the microphone will be muted for intercom calls. If Intercom Mute is disabled, the microphone will work for intercom calls. Intercom Mute is disabled by default.

### Intercom Tone

You can enable or disable the phone to play a warning tone when receiving an intercom call. If Intercom Tone is enabled, the phone will play a warning tone before answering the intercom call. If Intercom Tone is disabled, the phone will automatically answer the intercom call without warning. Intercom Tone is enabled by default.

### Intercom Barge

You can enable or disable the phone to automatically answer an incoming intercom call while there is already an active call on the phone. If Intercom Barge is enabled, the phone will automatically answer the intercom call and place the active call on hold. If Intercom Barge is disabled, the phone will handle an incoming intercom call like a waiting call. Intercom Barge is disabled by default.

#### Note

To enable the phone to receive a new incoming call when it has an active call, make sure that call waiting feature is enabled on the phone in advance. For more information, refer to [Call Waiting](#) on page 144.

**To configure intercom features via phone user interface:**

1. Press **Menu->Features->Intercom**.
2. Make the desired changes.



3. Press the **Save** soft key to accept the change or the **Back** soft key to cancel.

Intercom features are configurable via web user interface at the path **Features->Intercom**.

## Using Intercom

You can use the intercom key in the following ways:

- Place a call to the target extension
- Pick up an incoming call of the target extension

### Note

To use the intercom key to pick up an incoming call, make sure the intercom subscription feature is enabled. For more information, contact your system administrator.

## Placing an Intercom Call to the Target Extension

### To place an intercom call when the target phone is idle:

1. Press the intercom key.  
The target extension plays a warning tone and automatically answers the call in the hands-free (speakerphone) mode by default.
2. To end the intercom call, press the intercom key again or the **End Call** soft key.

## Picking up an Incoming Call of the Target Extension

When the target extension receives an incoming call, the intercom key LED of the target extension will flash green. If you configure the directed call pickup code in advance, you can pick up the target extension's incoming call by pressing the intercom key. You can configure the directed call pickup code when configuring an intercom key. For more information, refer to [Configuring an Intercom Key](#) on page 181.

**To pick up an incoming call when the monitored phone is ringing:**

1. Press the intercom key.

The incoming call of the target extension is answered on the IP phone.

**Note**

If the directed call pickup code is not configured, the phone will place a call to the target extension instead of picking up an incoming call of the target extension when you press the intercom key.

## Multicast Paging

You can use multicast paging to quickly and easily broadcast time sensitive announcements to users who are listening to a specific multicast group and a specific channel. You can configure a multicast paging key or the paging list key on the phone, which allows you to send a Real Time Transport Protocol (RTP) stream to the pre-configured multicast address(es) and channel(s) without involving SIP signaling. You can configure the phone to receive an RTP stream from pre-configured multicast listening address(es) and channel(s) without involving SIP signaling. You can specify up to 31 multicast listening addresses and channels.





The following describes 31 paging channels:

- **0:** You can broadcast audio to channel 0. Note that the Yealink IP phones running old firmware version (old paging mechanism) can be regarded as listening to channel 0. It is the default channel.
- **1 to 25:** You can broadcast audio to a specific channel. We recommend that you specify these channels when broadcasting with Polycom IP phones which have 25 channels you can listen to.
- **26 to 30:** You can broadcast audio to a specific channel. We recommend that you specify these channels when broadcasting with Yealink IP phones running new firmware version (new paging mechanism).

The IP phones will automatically ignore all incoming multicast paging calls on the different channel.

## Sending RTP Stream

**To configure a multicast paging key via phone user interface:**

1. Press **Menu->Features->DSS Keys**.
2. Select the desired DSS key.
3. Press  or  , or the **Switch** soft key to select **Key Event** from the **Type** field.
4. Press  or  , or the **Switch** soft key to select **Multicast Paging** from the **Key Type** field.
5. (Optional.) Enter the string that will appear on the LCD screen in the **Label** field.

6. Enter the multicast IP address and port number (e.g., 224.5.6.20:10008) in the **Value** field.  
The valid multicast IP addresses range from 224.0.0.0 to 239.255.255.255.
7. Enter the desired channel in the **Channel** field.  
The valid channel ranges from 0 to 30.

Line Key 2	
1. Type:	Key Event
2. Key Type:	Multicast Paging
3. Label:	
4. Value:	224.5.6.20:10008
5. Channel:	0
<div style="display: flex; justify-content: space-between;"> <span>Back</span> <span>123</span> <span>Delete</span> <span>Save</span> </div>	

8. Press the **Save** soft key to accept the change or the **Back** soft key to cancel.

Multicast paging key is configurable via web user interface at the path **Dsskey->Line Key**.

#### To configure a paging list key via phone user interface:

1. Press **Menu->Features->DSS Keys**.
2. Select the desired DSS key.
3. Press ◀ or ▶, or the **Switch** soft key to select **Key Event** from the **Type** field.
4. Press ◀ or ▶, or the **Switch** soft key to select **Paging List** from the **Key Type** field.
5. (Optional.) Enter the string that will appear on the LCD screen in the **Label** field.

Line Key 3	
1. Type:	Key Event
2. Key Type:	Paging List
3. Label:	
<div style="display: flex; justify-content: space-between;"> <span>Back</span> <span>2aB</span> <span>Delete</span> <span>Save</span> </div>	

6. Press the **Save** soft key to accept the change or the **Back** soft key to cancel.

Paging list key is configurable via web user interface at the path **Dsskey->Line Key**.

#### To configure paging list via phone user interface:

1. Press the paging list key when the phone is idle.  
If the paging list key is not configured, you can also press  
**Menu->Features->Others->Paging List** to configure the paging list.
2. Press ▲ or ▼ to select a desired paging group.

The default tag is Empty if it is not configured before.

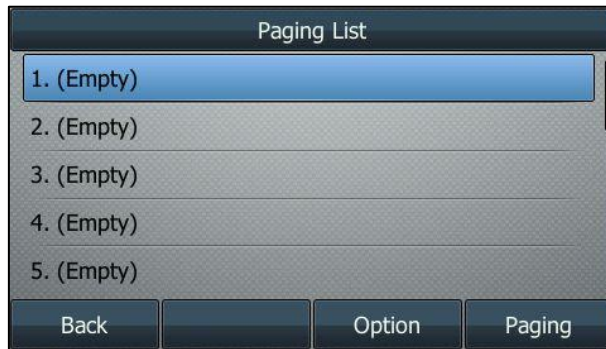

3. Press the **Option** soft key, and then press the **Edit** soft key from the prompt list.
4. Enter the multicast IP address and port number (e.g., 224.5.6.20:10008) in the **Address** field.

The valid multicast IP addresses range from 224.0.0.0 to 239.255.255.255.

5. Enter the group name in the **Label** field.
6. Enter the desired channel in the **Channel** field.



The valid channel ranges from 0 to 30.



7. Press the **Save** soft key to accept the change.
8. Repeat steps 2 to 7, you can add more paging groups.

Paging list is configurable via web user interface at the path **Directory->Multicast IP**.

**To delete a paging group via phone user interface:**

1. Press the paging list key when the phone is idle.
2. Press  or  to select a desired paging group.
3. Press the **Option** soft key, and then select **Delete** from the prompt list.



The LCD screen prompts “Delete selected paging group?”.



4. Press the **OK** soft key to accept the change or the **Cancel** soft key to cancel.

If you want to delete all paging groups, you can press the **Delete All** soft key.

You can also configure the phone to use a default codec for sending multicast RTP stream via web user interface.

**To configure a default codec for multicast paging via web user interface:**

1. Click on **Features->General Information**.
2. Select the desired codec from the pull-down list of **Multicast Codec**.

The default codec is G722.

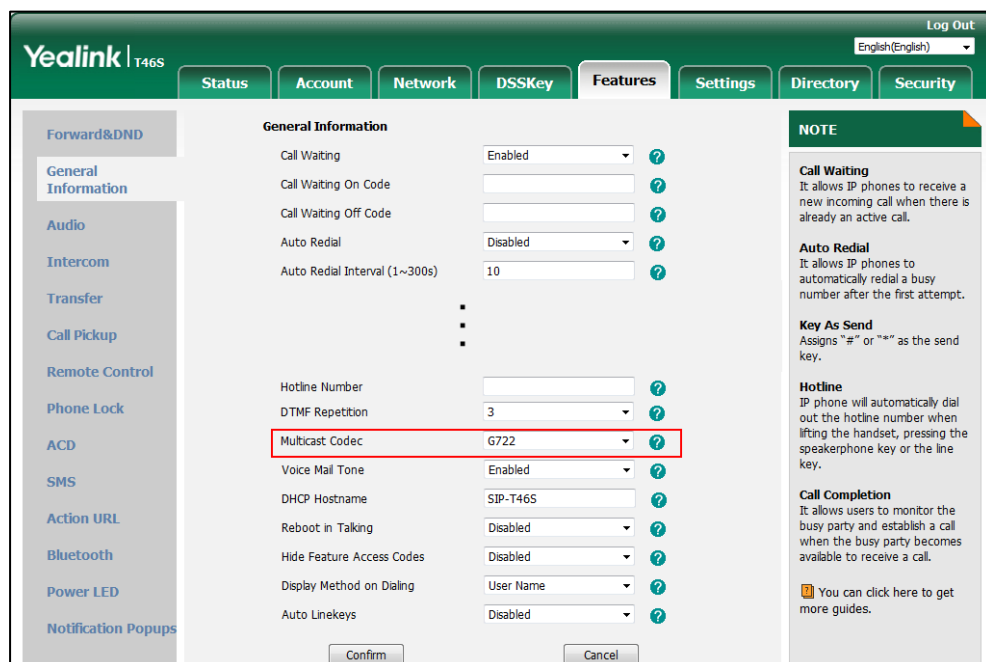

3. Click **Confirm** to accept the change.

**Note**

If G722 codec is used for multicast paging, the LCD screen will display the icon  to indicate that it is providing high definition voice.

Default codec for multicast paging is configurable via web user interface only.

## Receiving RTP Stream

You can configure the phone to receive a Real Time Transport Protocol (RTP) stream from the pre-configured multicast address(es) and channel(s) without involving SIP signaling. You can specify up to 31 multicast addresses and channels that the phone listens to on the network.

**Note**

RTP stream is listened in the hands-free (speakerphone) mode by default. If you want to listen the RTP stream using the engaged audio device (speakerphone, handset or headset), contact your system administrator for more information.

Fixed volume to play RTP stream for specified paging group is configurable by your system administrator.

How the phone handles incoming multicast paging calls depends on Paging Barge, Ignore DND and Paging Priority Active parameters configured via web user interface.

### Paging Barge

The paging barge parameter defines the priority of the voice call in progress. If the priority of an incoming multicast paging call is lower than that of the active call, it will be ignored automatically. Valid values in the Paging Barge field:

- **1 to 31:** Define the priority of the active call, 1 with the highest priority, 31 with the lowest.
- **Disabled:** The voice call in progress will take precedence over all incoming paging calls.

### Ignore DND

The ignore DND parameter defines the lowest priority of multicast listening address from which the phone can receive an RTP stream when DND is activated. If a priority is selected from the pull-down list of Ignore DND, the phone will ignore incoming multicast paging calls with lower priorities when DND is activated in phone mode. Valid values in the Ignore DND field:

- **1 to 31:** Define the lowest priority of the multicast listening address from which the phone can receive an RTP stream, 1 with the highest priority, 31 with the lowest.
- **Disabled:** All the incoming multicast paging calls will be ignored when DND is activated in phone mode.

The phone will automatically answer all incoming multicast paging calls when DND is activated in custom mode.

### Paging Priority Active

The paging priority active parameter decides how the phone handles incoming multicast paging calls when there is already a multicast paging call on the phone. If enabled, the phone will ignore incoming multicast paging calls with lower priorities, otherwise, the phone will answer incoming multicast paging calls automatically and place the previous multicast paging call on hold. If disabled, the phone will automatically ignore all incoming multicast paging calls.

#### To configure multicast listening addresses via web user interface:

1. Click on **Directory->Multicast IP**.
2. Select the desired value from the pull-down list of **Paging Barge**.
3. Select the desired value from the pull-down list of **Ignore DND**.
4. Select the desired value from the pull-down list of **Paging Priority Active**.
5. Enter the multicast IP address(es) and port number (e.g., 224.5.6.20:10008) which the phone listens to for incoming RTP multicast in the **Listening Address** field.
6. (Optional.) Enter the label in the **Label** field.  
Label will appear on the LCD screen when receiving the multicast RTP stream.
7. Select the desired channel to listen from the pull-down list of **Channel**.

The default channel is 0.

The screenshot shows the 'Multicast Listening' configuration page in the Yealink T46S web interface. The page has a green header with the Yealink logo and 'T46S' model number. There are navigation tabs for Status, Account, Network, Dsskey, Features, Settings, Directory, and Security. The 'Directory' tab is active. On the left, there is a sidebar with links to Local Directory, Remote Phone Book, Phone Call Info, LDAP, Multicast IP, and Setting. The main content area is titled 'Multicast Listening' and contains three configuration fields: 'Paging Barge' set to 31, 'Ignore DND' set to Disabled, and 'Paging Priority Active' set to Enabled. Below these fields is a table with 10 rows, each representing a listening address. The first row is highlighted with a red box and contains the following data: '1 IP Address', '224.5.6.20:10008', 'Product', '0', and '1'. The other rows have empty fields for IP Address, Listening Address, and Label, and '0' for Channel and '2-10' for Priority. On the right side, there is a 'NOTE' box with the following text: 'Multicast Paging: Multicast paging allows IP phones to send/receive Real-time Transport Protocol (RTP) streams to/from the pre-configured multicast address(es) without involving SIP signaling. Up to 10 listening multicast addresses can be specified on the IP phone. You can click here to get more guides.'

8. Click **Confirm** to accept the change.

#### Note

The priorities of listening addresses are predefined: 1 with the highest priority, 31 with the lowest. Multicast listening addresses are configurable via web user interface only.

## Using Multicast Paging

### To send RTP stream via a multicast paging key when the receiver's phone is idle:

1. Press the multicast paging key when the phone is idle.

The phone sends RTP to a preconfigured multicast address (IP: Port).

Both the sender's and receiver's phones play a warning tone and the receiver automatically answers the multicast RTP session in the hands-free (speakerphone) mode.

The multicast paging key LED illuminates solid green.

The following figure shows a multicast RTP session on the phone:





2. You can do the following:

- To place the current multicast RTP session on hold, press the **Hold** soft key.  
The sender's phone places the multicast RTP session on hold and receiver's phone releases the session.  
To resume the held multicast RTP session, press the **Resume** soft key.  
The multicast RTP session is established again.
- To end the multicast RTP session, press the **End Call** soft key.

### Note

Multicast RTP is one way only from the sender to the multicast address(es) (receiver). For outgoing RTP multicasts, all other existing calls on the phone will be placed on hold.

### To send RTP stream via a paging list key when the receiver's phone is idle:

1. Press the paging list key when the phone is idle.
2. Press  or  to select the desired paging group.
3. Press  or the **Paging** soft key to send RTP.
4. You can do the following:
  - To place the current multicast RTP session on hold, press the **Hold** soft key.  
The sender's phone places the multicast RTP session on hold and receiver's phone releases the session.

To resume the held multicast RTP session, press the **Resume** soft key.

The multicast RTP session is established again.

- To end the multicast RTP session, press the **End Call** soft key.

## Music on Hold

Music on hold (MoH) is the business practice of playing recorded music to fill the silence that would be heard by the party placed on hold. To use this feature, you should specify a SIP URI pointing to a Music on Hold Server account. When a call is placed on hold, the phone will send a SIP INVITE message to the Music on Hold Server account. The Music on Hold Server account automatically answers the SIP INVITE messages and immediately plays audio from some source located anywhere (LAN, Internet) to the held party. Contact your system administrator for the SIP URI.

**Note**

If your server supports the MOH feature, you can also upload the custom music file into it directly. For more information, contact your service provider.

**To configure music on hold server via web user interface:**

1. Click on **Account**->**Advanced**.
2. Select the desired account from the pull-down list of **Account**.
3. Enter the SIP URI (e.g., sip:moh@sip.com) in the **Music Server URI** field.

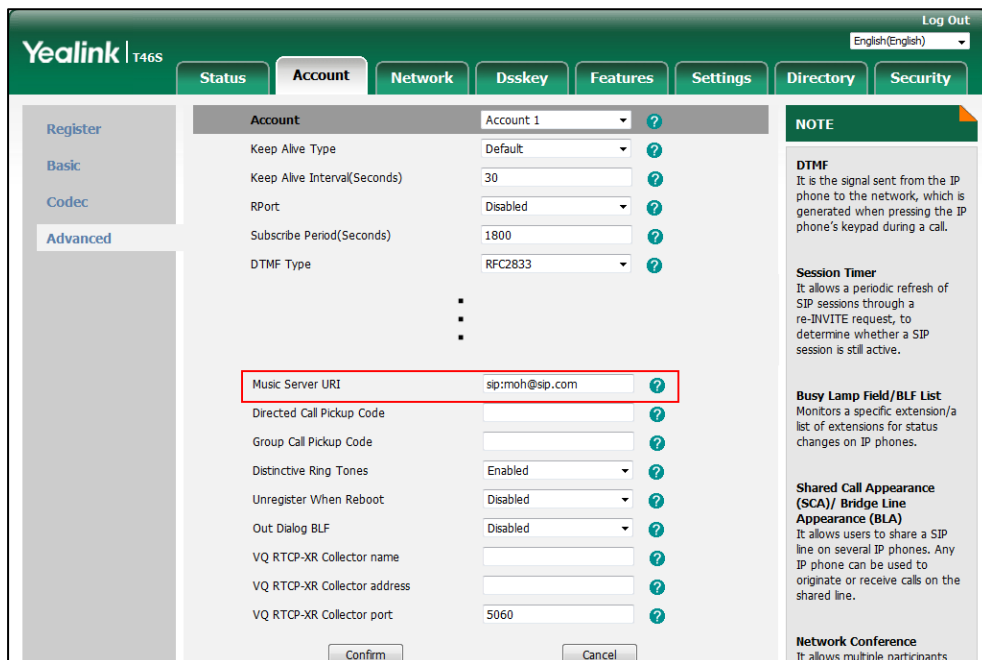

4. Click **Confirm** to accept the change.

When you place a call on hold, the held party can hear the music.

**Note**

For this feature to function, all involved parties cannot use encrypted RTP (SRTP).  
Music on hold server is configurable via web user interface only.



## Automatic Call Distribution (ACD)

ACD is often used in offices for customer service, such as call center. The ACD system handles large volumes of incoming calls from callers who have no need to talk to a specific person but who require assistance from any of multiple persons at the earliest opportunity. ACD on the SIP-T46S IP phone allows the ACD system to distribute large volumes of incoming calls to the registered ACD users. To use this feature, you should configure an ACD key in advance. For more information on ACD key icon indicators, refer to [Icon Instructions](#) on page 3.

**Note**

Make sure ACD is enabled on your IP phone. For more information, contact your system administrator.

### To configure an ACD key via phone user interface:

1. Press **Menu**->**Features**->**DSS Keys**.
2. Select the desired DSS key.
3. Press  or , or the **Switch** soft key to select **ACD** from the **Type** field.
4. (Optional.) Enter the string that will appear on the LCD screen in the **Label** field.



5. Press the **Save** soft key to accept the change or the **Back** soft key to cancel.

ACD key is configurable via web user interface at the path **Dsskey**->**Line Key**.

### To log into the ACD system:

1. Press the ACD key when the phone is idle.

The LCD screen prompts you the following information:

**User ID:** the identity used to log into the queue.

**Password:** the password used to log into the queue.



2. Press the **Login** soft key to log in.

**Note**

Contact your system administrator for the User ID and Password to access the ACD system.

After configuring an ACD key, you can press the ACD key to log into the ACD system. After logging in, you are ready to receive calls from the ACD system. You can press the ACD key to show your current ACD user status. You can press the **Available/Unavailable** soft key to change your ACD user status. ACD user status synchronizes on both IP phone and ACD system.

When you set the ACD user status to be available, the ACD key LED illuminates solid green, and then the server begins distributing calls to your IP phone.

When you set the ACD user status to be unavailable, the ACD key LED flashes green, and then the server temporarily stops distributing calls to your IP phone. To log out of the ACD system, press the **Logout** soft key.

**Note**

It is recommended you configure no more than one ACD key per phone. At any time, at most one ACD key can be in progress on your phone.

## Shared Call Appearance (SCA)

You can use SCA feature to share an extension which can be registered on two or more IP phones at the same time. The shared line is indicated by a different line icon.

In the following figure, the first line is private and the second line is shared:



If two phones share a line, an incoming call to this extension will cause both phones to ring simultaneously. The incoming call can be answered on either phone but not both.

This feature is very useful in the boss and secretary scenario. For example, the secretary can share the boss's extension on her phone. When there is an incoming call to the extension of the boss, both the phones of the boss and the secretary will ring simultaneously. Either the boss or the secretary can answer the call. Calls on the shared line can be placed on hold, barged in or retrieved from another shared phone.



## Configuring SCA Feature on the IP Phone

You can configure a primary account on the IP phone and other alternate accounts on the other IP phones. In a SCA Hybrid Key System scenario, you can automatically assign multiple DSS keys with Line type for a registered shared line on the phone (If auto linekeys feature is enabled). For example, party A, party B share the account 4603, phone A registers the primary account 4603 and assigns line key 1 and line key 2 for the account 4603, phone B registers the alternate account 4603\_1 and assigns line key 1 and line key 2 for the account 4603\_1, phone C registers the account 4604.

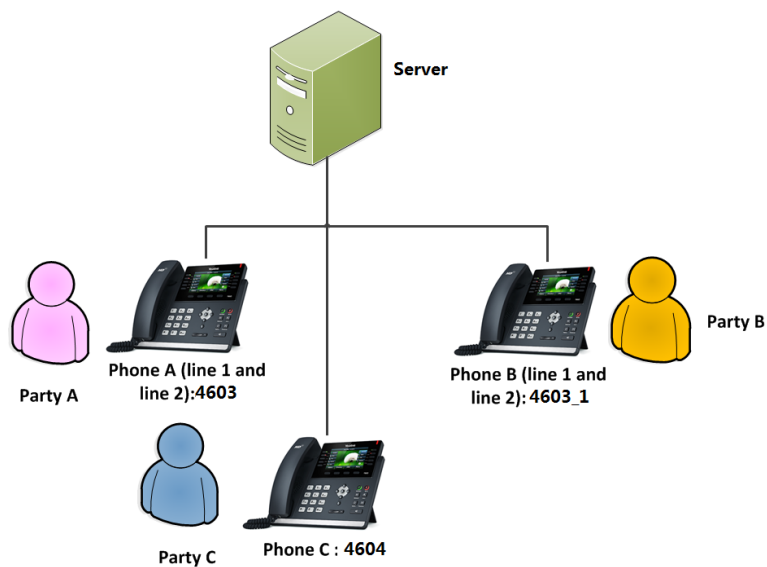

**To configure the auto linekeys feature via web user interface:**

1. Click on **Features->General Information**.
2. Select **Enabled** from the pull-down list of **Auto LineKeys**.

If **Auto LineKeys** is enabled, you can automatically assign multiple DSS keys with Line type for a registered shared line on the phone.

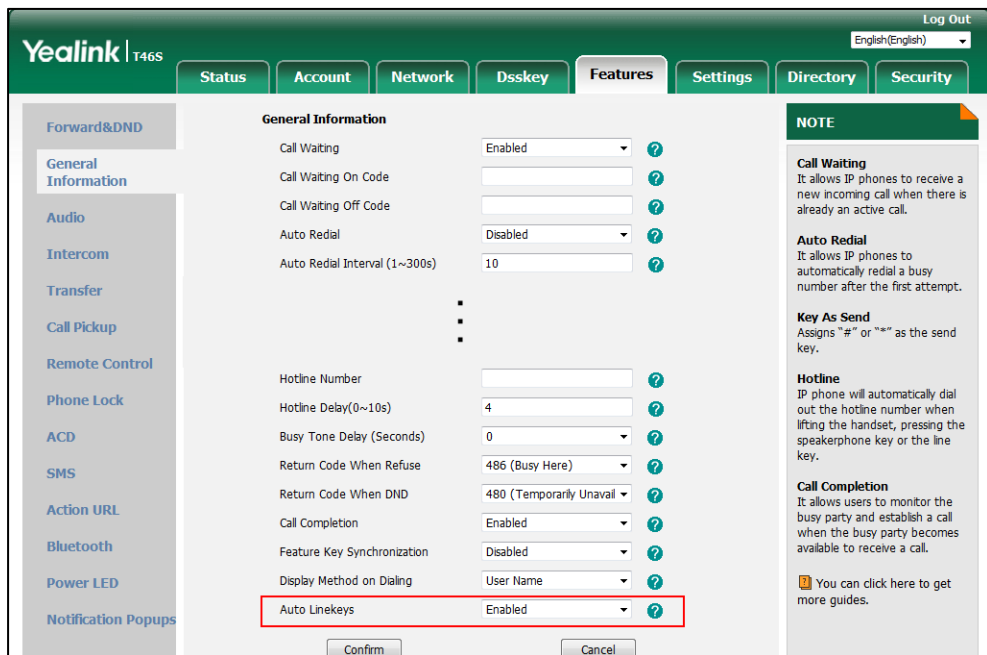

3. Click **Confirm** to accept the change.

**To configure the shared line settings and the number of line key on phone A via web user interface:**

1. Register the primary account 4603.

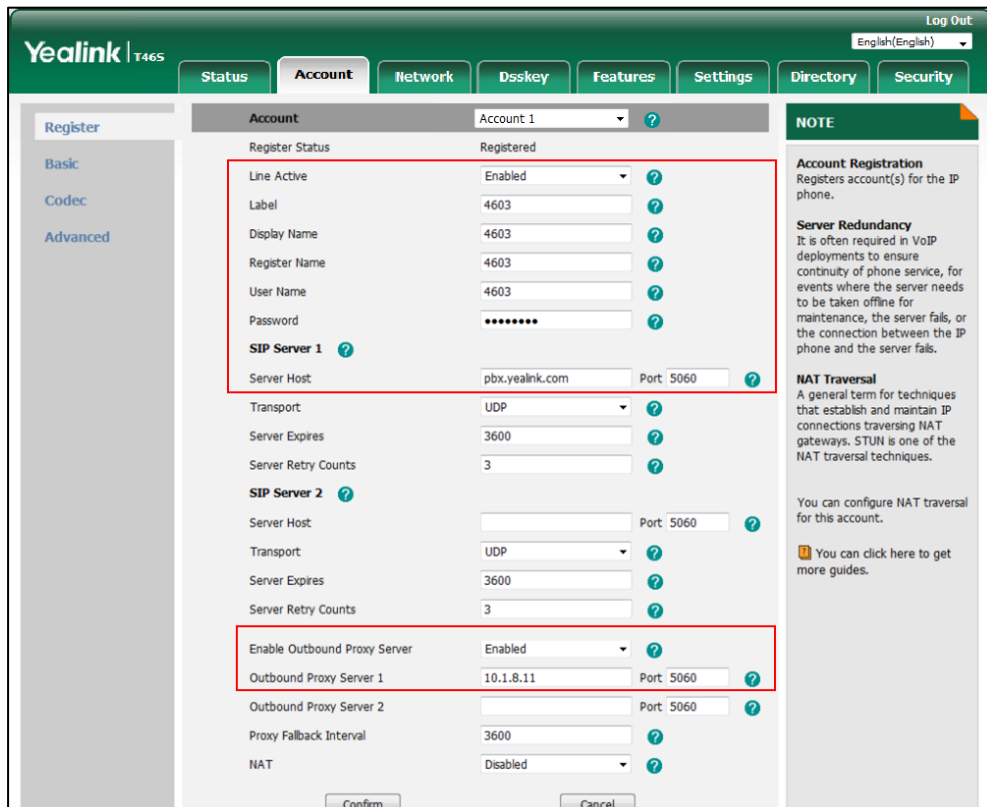

- Click on **Advanced**, and then select **Shared Call Appearance** from the pull-down list of **Shared Line**.
- Enter the desired number in the **Number of line key** field.  
This field appears only if **Auto Linekeys** is enabled.  
The default value is 1. In this example, the value is set to 2.

The screenshot shows the Yealink T46S web interface. The 'Advanced' settings for 'Account 1' are displayed. The 'Shared Line' dropdown menu is set to 'Shared Call Appearance', and the 'Number of line key' field is set to '2'. Both are highlighted with red boxes. The interface includes a sidebar with 'Register', 'Basic', 'Codec', and 'Advanced' options, and a 'NOTE' section on the right with information about DTMF, Session Timer, Busy Lamp Field/BLF List, Shared Call Appearance (SCA)/ Bridge Line Appearance (BLA), and Network Conference.

- Click **Confirm** to accept the change.

The phone A will automatically configure the line keys from the first unused DSS key, according to the configured number in the **Number of line key** field.

**To configure the shared line settings and the number of line key on phone B via web user interface:**

- Register the alternate account 4603\_1.

(Enter the primary account 4603 in the **Register Name** field.)

The screenshot shows the 'Account' configuration page for 'Account 1'. The 'SIP Server 1' section is highlighted with a red box and contains the following fields:

Line Active	Enabled	?
Label	4603_1	?
Display Name	4603_1	?
Register Name	4603	?
User Name	4603_1	?
Password	*****	?
SIP Server 1		?
Server Host	pbx.yealink.com	Port: 5060
Transport	UDP	?
Server Expires	3600	?
Server Retry Counts	3	?

The 'Enable Outbound Proxy Server' section is also highlighted with a red box and contains the following fields:

Enable Outbound Proxy Server	Enabled	?
Outbound Proxy Server 1	10.1.8.11	Port: 5060
Outbound Proxy Server 2		Port: 5060
Proxy Fallback Interval	3600	?
NAT	Disabled	?

On the right side, there is a 'NOTE' section with the following text:

**Account Registration**  
Registers account(s) for the IP phone.

**Server Redundancy**  
It is often required in VoIP deployments to ensure continuity of phone service, for events where the server needs to be taken offline for maintenance, the server fails, or the connection between the IP phone and the server fails.

**NAT Traversal**  
A general term for techniques that establish and maintain IP connections traversing NAT gateways. STUN is one of the NAT traversal techniques.

You can configure NAT traversal for this account.

You can click here to get more guides.

2. Click on **Advanced**, select **Shared Call Appearance** from the pull-down list of **Shared Line**.
3. Enter the desired number in the **Number of line key** field.  
This field appears only if **Auto Linekeys** feature is enabled.  
The default value is 1. In this example, the value is set to 2.

The screenshot shows the 'Account' configuration page for 'Account 1'. The 'Advanced' section is selected in the left sidebar. The 'Shared Line' field is highlighted with a red box and contains the following fields:

Keep Alive Type	Default	?
Keep Alive Interval(Seconds)	30	?
RPort	Disabled	?
Subscribe Period(Seconds)	1800	?
DTMF Type	RFC2833	?
BLF List Retrieve Call Parked Code		?
Shared Line	Shared Call Appearance	?
Call Pull Feature Access Code		?
Subscribe for MWI	Disabled	?
MWI Subscription Period(Seconds)	3600	?
VQ RTPC-XR Collector name		?
VQ RTPC-XR Collector address		?
VQ RTPC-XR Collector port	5060	?
Number of line key	2	?

On the right side, there is a 'NOTE' section with the following text:

**DTMF**  
It is the signal sent from the IP phone to the network, which is generated when pressing the IP phone's keypad during a call.

**Session Timer**  
It allows a periodic refresh of SIP sessions through a re-INVITE request, to determine whether a SIP session is still active.

**Busy Lamp Field/BLF List**  
Monitors a specific extension/a list of extensions for status changes on IP phones.

**Shared Call Appearance (SCA)/ Bridge Line Appearance (BLA)**  
It allows users to share a SIP line on several IP phones. Any IP phone can be used to originate or receive calls on the shared line.

**Network Conference**  
It allows multiple participants

- Click **Confirm** to accept the change.

The phone B will automatically configure the line keys from the first unused DSS key, according to the configured number in the **Number of line key** field.

## Configuring private hold soft key or private hold key

Public hold allows any shared line to retrieve the held call. Private hold only allows the hold party to retrieve the held call. For example, you can retrieve the held call on either phone A or phone B when you place a call on public hold; you can retrieve the held call only on phone A when you place a call on private hold on phone A. By default, the private hold soft key isn't displayed on the LCD screen. You need to configure either the private hold soft key or a private hold key before you place the call on private hold.

### To configure the private hold soft key via web user interface:

- Click on **Settings->Softkey Layout**.
- Select **Enabled** from the pull-down list of **Custom Softkey**.
- Select **On Talk** from the pull-down list of **Call States**.
- Select **PriHold** from the **Unselected Softkeys** column and then click  .  
The **PriHold** appears in the **Selected Softkeys** column.

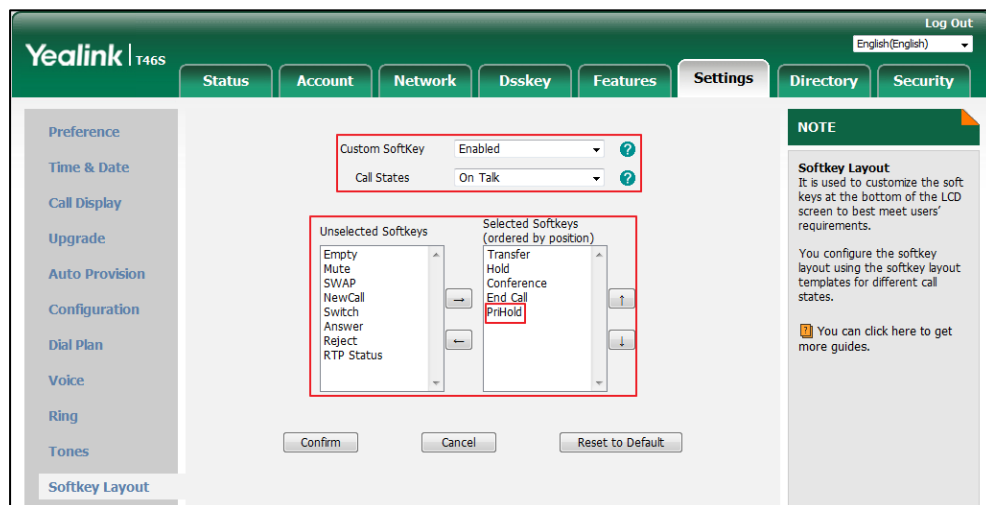





- Click **Confirm** to accept the change.

### Note

Configuring the private hold soft key may affect the softkey layout in the Talking state. Contact your administrator for more information.

### To configure a private hold key via phone user interface:

- Press **Menu->Features->DSS Keys**.
- Select the desired DSS key.
- Press  or  , or the **Switch** soft key to select **Key Event** from the **Type** field.

- Press  or , or the **Switch** soft key to select **Private Hold** from the **Key Type** field.



- (Optional.) Enter the string that will appear on the LCD screen in the **Label** field.
- Press the **Save** soft key to accept the change or the **Back** soft key to cancel.

### Configuring call pull feature

Call pull feature allows users to retrieve an existing call from another shared phone that is in active or public hold status.

**To configure the call pull feature access code via web user interface:**

- Click on **Account->Advanced**.
- Select the desired account from the pull-down list of **Account**.
- Enter the call pull feature access code (e.g., \*11) in the **Call Pull Feature Access Code** field.

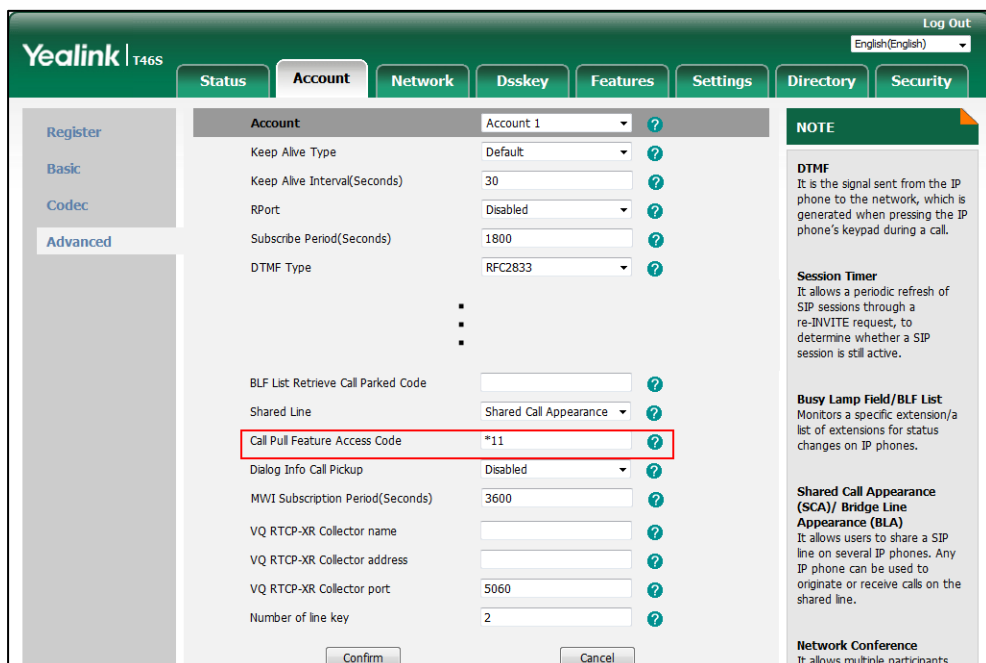

- Click **Confirm** to accept the change.

The phone will dial out “\*11” automatically when you press the **Call Pull** soft key.

## Using SCA Feature on the IP Phone

This section provides you with detailed information on using the SIP-T46S IP phone in a SCA Hybrid Key System scenario. In a SCA Hybrid Key System scenario, the status of the line key LED which associates with a shared line will change. For more information on line key LED indicators, refer to [LED Instructions](#) on page 9.

You can do the following using the IP phone in a SCA Hybrid Key System scenario:





- Placing calls
- Answering calls
- Placing a call on hold
- Retrieving a held call
- Barging in an active call
- Call Pull

### Placing Calls

You can have one call or multiple calls on the shared line.



#### To place a call on the shared line:



Do one of following:

- Enter the desired number using the keypad when the phone is idle. Press , , or the **Send** soft key.  
The phone will dial the entered number using the first line key.
- Press the line key when the phone is idle to enter the dialing screen.  
Enter the desired number using the keypad and then press , , or the **Send** soft key.  
The phone will dial the entered number using the selected line key.

#### To place multiple calls on the shared line:

You can have more than one call on the shared line. To place a new call when there is an active call on the line key 1 of phone A, do one of the following on phone A:

- Press  or the **Hold** soft key. The original call is placed on hold.  
Press the **New Call** soft key to enter the dialing screen.  
Enter the desired number using the keypad.  
Press , , or the **Send** soft key.  
Phone A will dial the entered number using the line key 2 automatically.
- Press the line key. The original call is placed on hold.  
Enter the desired number using the keypad.

Press , , or the **Send** soft key.

Phone A will dial the entered number using the selected line key.





## Answering Calls

You can have one call or multiple calls on the shared line. Incoming calls will be distributed evenly among the available line keys.

### To answer a call on the shared line:

When an incoming call arrives on the shared line, the phone A and phone B will ring simultaneously, and the LED indicators of the line key 1 on both phone A and phone B will flash green. You can answer the incoming call on either phone A or phone B but not both.

Do one of the following on phone A or phone B:

- Press the line key 1, ,  or the **Answer** soft key on phone A.  
The LED indicator of the line key 1 on phone A will illuminate solid green and phone B will illuminate solid Red.
- Press the line key 1, ,  or the **Answer** soft key on phone B.  
The LED indicators of the line key 1 on phone A will illuminate solid red and phone B will illuminate solid green.

### To answer multiple calls on the shared line:

An incoming call arrives on the shared line when there is an active call on phone A's line key 1. The LED indicators of the line key 2 on both phone A and phone B will fast flash green. You can answer the incoming call on either phone A or phone B. The LCD screen of phone A displays the information of the incoming call (e.g., "Incoming Call: pbx.yealink.com").

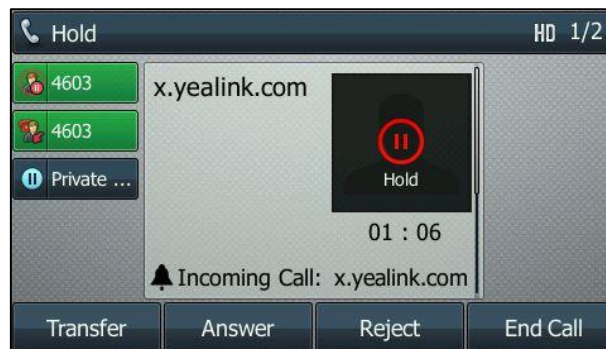



**Note** Make sure call waiting feature is enabled on phone A. For more information, refer to [Call Waiting](#) on page 144.

Do one of the following on phone A:

- Press the line key 2. Phone B stops ringing.
- Press the **Answer** soft key. Phone B stops ringing.



- Press  to access the new call.
- Press  or the **Answer** soft key. Phone B stops ringing.

The incoming call is answered and the original call is placed on hold. The LED indicators of the line key 1 on phone A will slowly flash green and phone B will slowly flash red indicating that there is the held call on the line key 1. The LED indicators of the line key 2 on phone A will illuminate solid green and phone B will illuminate solid red indicating that there is an active call on the line key 2.

You can also answer the call on phone B. Do one of the following on phone B:

- Press the line key 2. Phone A stops ringing.
- Press  or the **Answer** soft key. Phone A stops ringing.

The LED indicators of the line key 2 on phone A will illuminate solid red and phone B will illuminate solid green indicating that there is an active call on the line key 2. Meanwhile, The LED indicators of the line key 1 phone A will illuminate solid green and phone B will illuminate solid red indicating that there is an active call on the line key 1.

#### Note

If the number of incoming calls is greater than the configured line keys, the line keys will be used by sequence circulation.

## Placing a Call on Hold

### To place a call on public hold:

1. Press  or the **Hold** soft key on phone A when party A and party C are talking.

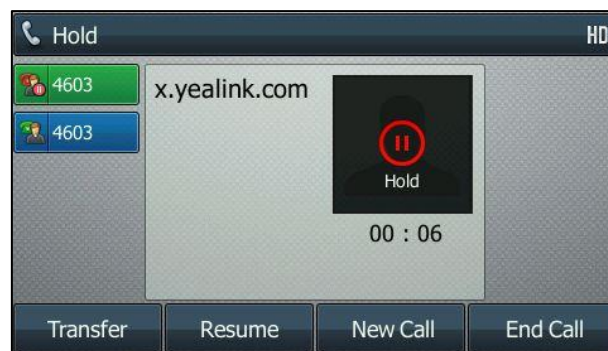

The line key LEDs on phone A slowly flash green and phone B slowly flash red when the shared line call is placed on hold.

**To place a call on private hold:**

1. Press the **PriHold** soft key or private hold key on phone A when there is an active call on the shared line (You may need to press the **More** soft key to see the **PriHold** soft key).

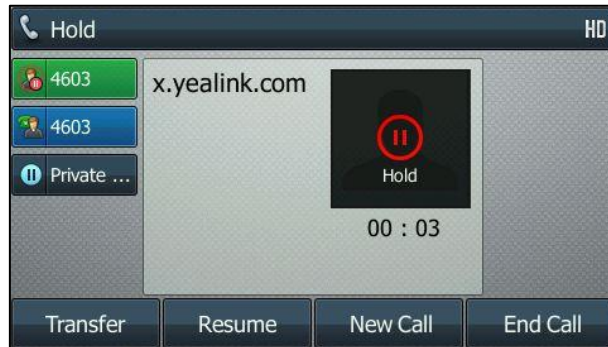

The line key LED flashes green slowly on phone A when the shared line call is placed on private hold.

## Retrieving a Held Call

**To retrieve a call placed on public hold:**

You can retrieve the public held call on either phone A or phone B.

**To retrieve the call on phone A:**

1. Press the line key with the slow-flashing green LED indicator,  or the **Resume** soft key.

The conversation between phone A and phone C is retrieved.

**To retrieve the call on phone B:**

Do one of the following:

- Press the line key with the slow-flashing red LED indicator.
- Long press the desired line key.

The **Cancel**, **Call Pull**, **New Call** and **Retrieve** soft keys appear on the LCD screen.



Press the **Retrieve** soft key to retrieve the call.

The conversation is established between phone B and phone C, phone A disconnects the call. And the line key LEDs on phone A illuminate solid red and phone B illuminate solid green.

#### To retrieve a call placed on private hold:

The private held call can be only retrieved by the hold party (party A).

Do one of the following:

- Press the line key with the slow-flashing green LED indicator.
- Press the **Resume** soft key on phone A.



## Barging In an Active Call

#### To interrupt the active call on the shared line:

If phone A has only one active call, do the following:

1. Long press the desired line key on phone B.  
The **Cancel**, **Call Pull**, **New Call** and **Barge In** soft keys appear on the LCD screen of phone B.



2. Press the **Barge In** soft key to interrupt the active call of phone A.  
Party B will set up a conference call with the other parties in the active call.
3. Press , the **Hold** or the **End Call** soft key.
  - If any party in the conference call presses  or the **Hold** soft key, two-way voice can be heard between the remaining parties.
  - If party A or party B presses the **End Call** soft key, the remaining parties are still connected. If the other party (not the shared line party) presses the **End Call** soft key, the conference call is ended.

You can also press the line key with the solid red LED indicator on phone B to set up a conference call with the other parties in the active call.

If phone A has more than one call, do the following:

1. Long press the desired line key on phone B.



The list of calls appears on the LCD screen of phone B.



2. Press or to select the active call.

The **Cancel**, **Call Pull**, **New Call** and **Barge In** soft keys appear when the active call is highlighted.



3. Press the **Barge In** soft key to interrupt the active call of phone A.  
Party B may hear a warning tone and then set up a conference call with the other parties of the active call.
4. Press , the **Hold** or the **End Call** soft key.
- If any party in the conference call presses , the **Hold** soft key, two-way voice can be heard between the remaining parties.
  - If party A or party B presses the **End Call** soft key, the remaining parties are still connected. If the other party (not the shared line party) presses the **End Call** soft key, the conference call is ended.

## Call Pull

Call pull feature allows users to retrieve an existing call from another shared phone that is in active or hold status. For example, when there is a call between phone A and phone C, you can use call pull feature on phone B to retrieve this call from phone A. Then the call is established between phone B and phone C.

### To retrieve a call from another shared phone:

If there is an active call between phone A and phone C, do the following:

1. Long press the desired line key on phone B.  
The **Cancel**, **Call Pull**, **New Call** and **Barge In** soft keys appear on the LCD screen of phone B.



2. Press the **Call Pull** soft key.  
The active call has been retrieved from the phone A successfully.  
If there is a held call between phone A and phone C, do the following:

1. Long press the desired line key on phone B.  
The **Cancel**, **Call Pull**, **New Call** and **Retrieve** soft keys appear on the LCD screen of phone B.



2. Press the **Call Pull** soft key.  
The held call has been retrieved from the phone A successfully.

## Bridged Lines Appearance (BLA)

BLA allows users to share a SIP line on two or more IP phones. Users can monitor the specific extension (BLA number) for status changes on each IP phone. To use this feature, a BLA group should be pre-configured on the server and one of them is specified as a BLA number. BLA depends on support from a SIP server.

In the following figure, the first line is private and the second line is shared:



Any IP phone can be used to originate or receive calls on the bridged line. An incoming call to the BLA number can be presented to multiple phones in the group simultaneously. The incoming call can be answered on any IP phone of the group but not all.

## Configuring BLA Feature on the IP Phone

You can share a BLA number on two or more phones. For example, phone A registers the account 14019833020 and assigns BLA number, phone B registers the account 10462190020 and assigns BLA number, phone C registers the account 14755608020. Phone A and phone B share the BLA number 14084588327.

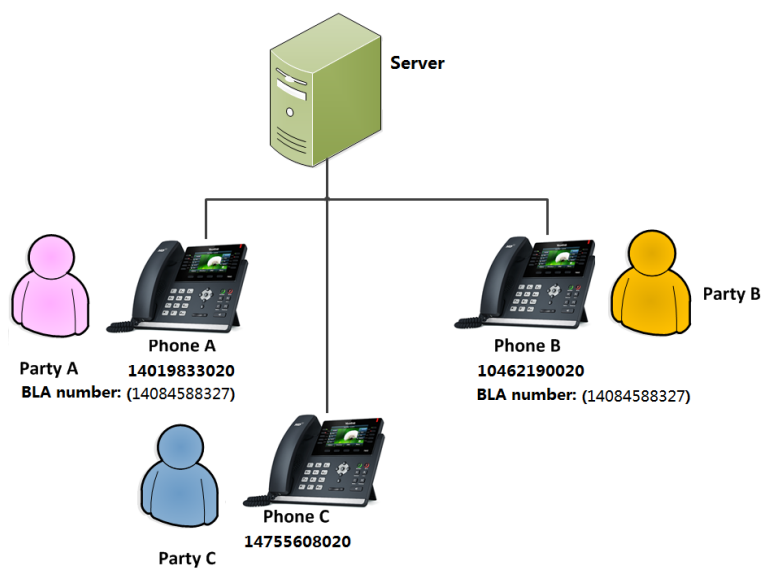

To register an account and configure BLA feature on phone A via web user interface:

1. Register the account 14019833020.

2. Click on **Advanced**, and then select **Draft BLA** from the pull-down list of **Shared Line**.
3. Enter the desired number in the **BLA Number** field.

4. Click **Confirm** to accept the change.

**To register an account and configure BLA feature on phone B via web user interface:**

1. Register the account 10462190020.

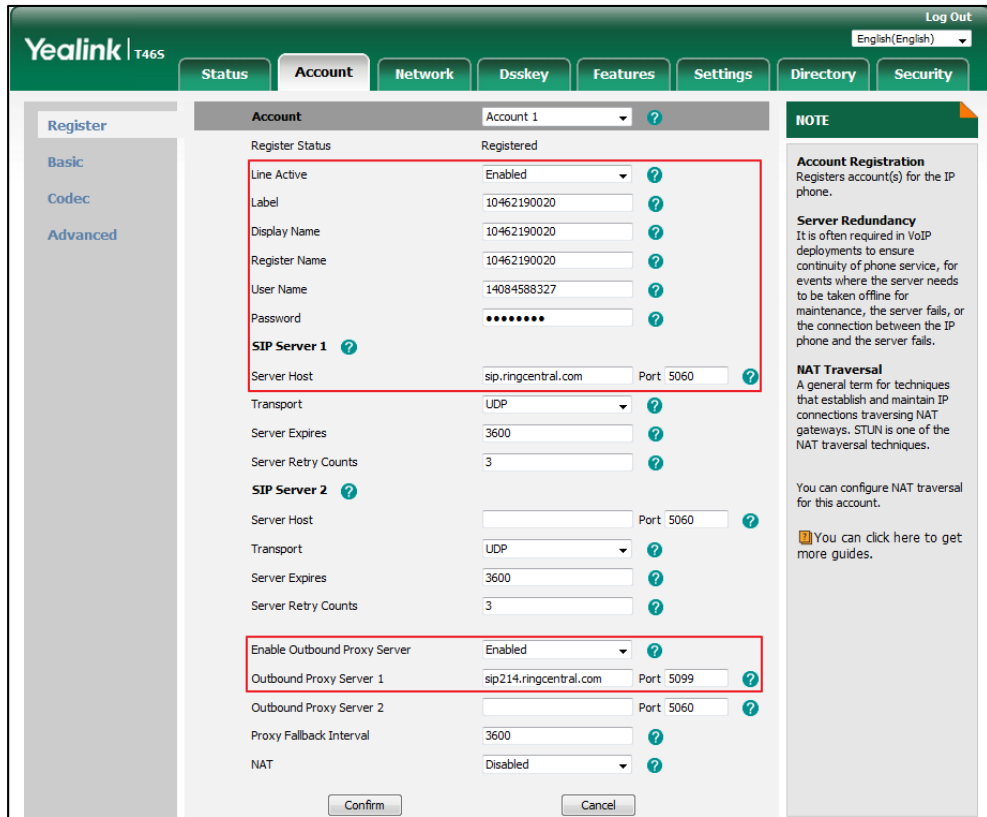

2. Click on **Advanced**, and then select **Draft BLA** from the pull-down list of **Shared Line**.
3. Enter the desired number in the **BLA Number** field.

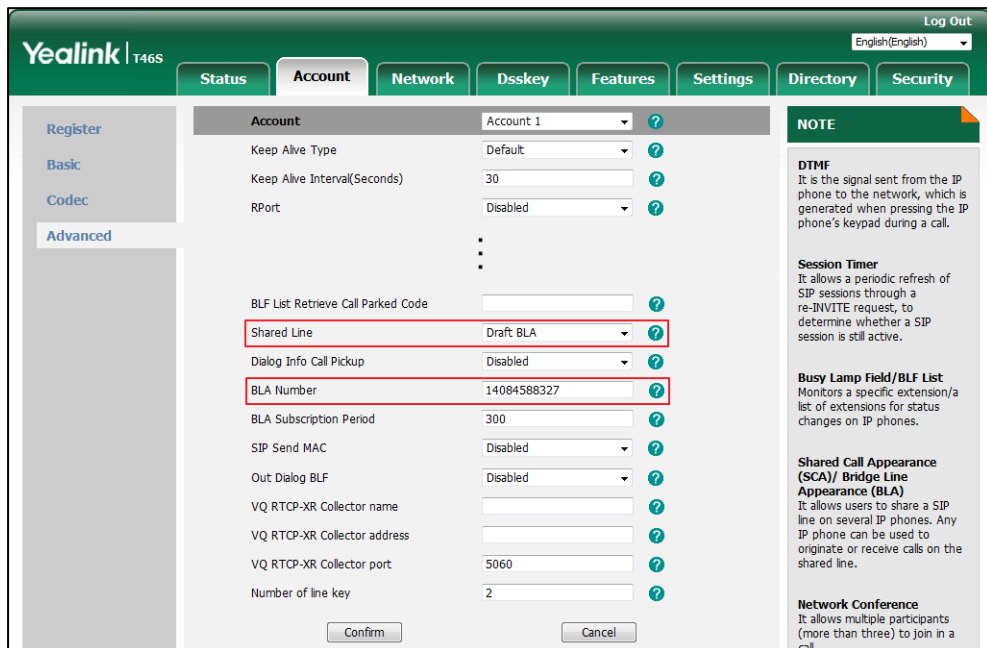

4. Click **Confirm** to accept the change.



## Using BLA Feature on the IP Phone

This section provides you with detailed information on using the SIP-T46S IP phone in a BLA scenario. In a BLA scenario, the status of the line key LED which associates with a bridged line will change. For more information on line key LED indicators, refer to [Icon Instructions](#) on page 3.

You can do the following using the IP phone in a BLA scenario:



- Placing calls
- Answering calls
- Place a call on hold
- Retrieving a held call

### Placing Calls

You can have one call or multiple calls on the bridged line.



#### To place a call on the bridged line:

Do one of following:

- Enter the desired number using the keypad when the phone is idle. Press , , or the **Send** soft key.

The phone will dial the entered number.

- Press the line key when the phone is idle to enter the dialing screen.

Enter the desired number using the keypad and then press , , or the **Send** soft key.

The phone will dial the entered number.



#### To place multiple calls on the bridged line:

You can have more than one call on the bridged line. To place a new call where there is an active call on phone A, do one of the following on the phone A:

- Press  or the **Hold** soft key. The original call is placed on hold.

Press the **New Call** soft key to enter the dialing screen.



Enter the desired number using the keypad.

Press , , or the **Send** soft key.

Phone A will dial the entered number.

- Press the line key. The original call is placed on hold.

Enter the desired number using the keypad.





Press , , or the **Send** soft key.

Phone A will dial the entered number.

## Answering Calls

When the phone C dials the BLA number "14084588327", an incoming call will arrive on the bridged lines. The phone A and phone B ring simultaneously and the LED indicators of the line key on both phone A and phone B will flash green. You can answer the incoming call on either phone A or phone B but not both.

Do one of the following on phone A or phone B:

- Press ,  or the **Answer** soft key on phone A.  
Phone B stops ringing. The LED indicator of the line key on the phone A will illuminate solid green. At the meanwhile, the LED indicator of the line key on the phone B will illuminate solid red indicating that there is an active call on the phone A.
- Press ,  or the **Answer** soft key on phone B.  
Phone A stops ringing. The LED indicator of the line key on the phone B will illuminate solid green. At the meanwhile, the LED indicator of the line key on the phone A will illuminate solid red indicating that there is an active call on the phone B.

## Placing a Call on Hold

**To place a call on hold:**

1. Press  or the **Hold** soft key on phone A when party A and party C are talking.  
The line key LEDs on phone A slowly flash green and phone B slowly flash red when the bridged line call is placed on hold.

## Retrieving a Held Call

If there is a held call between phone A and phone C, you can retrieve a held call on either phone A or phone B.

**To retrieve the held call on phone A:**

1. Press the line key with the slow-flashing green LED indicator,  or the **Resume** soft key on the phone A.  
The conversation between phone A and phone C is retrieved.

**To retrieve the held call on phone B:**

1. Press the line key with the slow-flashing red LED indicator on phone B.  
The conversation is established between phone B and phone C, phone A disconnects the call.

## Messages

### Short Message Service (SMS)

You can send and receive text messages using the SIP-T46S IP phone. New text messages can be indicated both acoustically and visually. When receiving a new text message, the phone will play a warning tone. The power indicator LED will slowly flash red, and the LCD screen will prompt “n New Text Message(s)” (“n” indicates the number of unread text messages. e.g., 1 New Text Message(s)) and an icon .

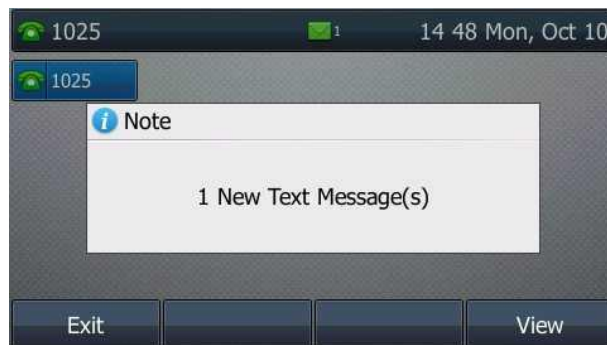

**Note** When the phone receives a text message, the text message prompt window will pop up by default, if you want to disable the feature, contact your system administrator for more information.

You can store text messages in your phone’s Inbox, Sentbox, Outbox or Draftbox. Each of the boxes can store up to 100 text messages. If the number of the text messages in one box is more than 100, the phone will directly delete the oldest text message in the box.

**Note** SMS is not available on all servers. Contact your system administrator for more information.

#### To read a text message:

1. Press **Menu->Message->Text Message->Inbox**.



2. Select the desired message and then press the **View** soft key.

**Note**

If the phone prompts receiving new text messages, you can also press the **View** soft key to read the new messages directly.

**To send a text message:**

1. Press **Menu->Message->Text Message->New Message**.
2. Compose the new text message.

You can press the **abc** soft key to change the input mode.



3. Press the **Send** soft key.
4. (Optional.) Press ◀ or ▶, or the **Switch** soft key to select the desired account from the **From** field.
5. Enter the number you want to send the message to in the **To** field.
6. Press the **Send** soft key to send the message or the **Back** soft key to cancel.

Sending a text message is configurable via web user interface at the path **Features->SMS**.

**To reply a text message:**

1. Press **Menu->Message->Text Message->Inbox**.
2. Select the desired message and then press the **Reply** soft key.
3. Compose the new text message. You can press the **abc** soft key to change the input mode.



4. Press the **Send** soft key after completing the content.

5. Check the **From** and **To** fields, and then press the **Send** soft key.

**To delete a text message:**

1. Press **Menu->Message->Text Message->Inbox (Sentbox, Outbox or Draftbox)**.
2. Select the desired message and then press the **Option** soft key.
3. Select **Delete** to delete the desired message, then press **OK**.

The LCD screen prompts "Delete the selected message?".



4. Press the **OK** soft key to delete this message or the **Cancel** soft key to cancel.

You can also delete all text messages by pressing the **Option** soft key and then select **Delete All**. For more information, refer to the above steps.

**Note**

You can also delete a specific message by pressing the **Delete** soft key after viewing.

## Voice Mail

You can leave voice mails for someone else using the SIP-T46S IP phone. You can also listen to voice mails that are stored in a voice mailbox. This feature is set up on the server side. It is not available on all servers.

When receiving a new voice mail, the phone will play a warning tone. The power indicator LED will slowly flash red, and the LCD screen will prompt "n New Voice Mail(s)" ("n" indicates the number of unread voice messages, e.g., 2 New Voice Mail(s)) and an icon  .

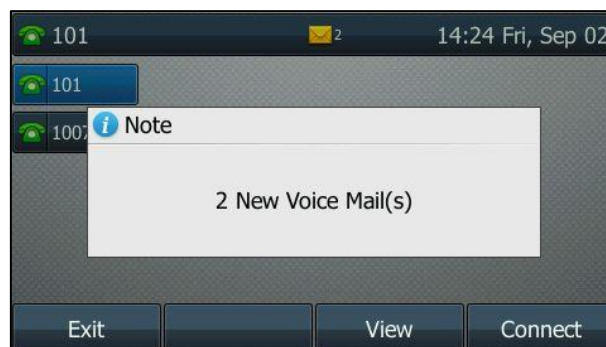

If the voice mail pop-up message box disappears, it won't pop up again unless the user receives a new voice mail or the user re-registers the account that has unread voice mail(s).

**Note**

You can configure the phone not to display the pop-up prompt, contact your system administrator for more information.

**To leave a voice mail:**

You can leave a voice mail for someone else when he/she is busy or inconvenient to answer the call. Follow the voice prompt from the system server to leave a voice mail, and then hang up.

**To configure voice mail access codes via phone user interface:**

1. Press **Menu->Message->Voice Mail->Set Voice Mail Code**.
2. Press the navigation keys to highlight the account which you want to set.
3. Press the **123** soft key to select the proper input mode and then enter the voice mail access code (e.g., \*4).



4. Press the **Save** soft key to accept the change or the **Back** soft key to cancel.

**Note**

Voice mail access codes must be predefined on the system server. Contact your system administrator for the more information.

**To listen to voice mails:**

1. When the LCD screen prompts that the phone receives a new voice mail and the power indicator LED slowly flashes red, you can press  or the **Connect** soft key to dial out the voice mail access code.
2. Follow the voice prompt to listen to your voice mails.

**Note**

Before listening to voice mails, make sure the voice mail access code has been configured. When all new voice mails are retrieved, the power indicator LED will go out.

**To view the voice mail via phone user interface:**

1. Press **Menu->Message->Voice Mail->View Voice Mail**.

The LCD screen displays the amount of new and old voice mails.



2. Select an account and then press the **Connect** soft key to listen to voice mails.

## Message Waiting Indicator (MWI)

The SIP-T46S IP phone supports MWI when receiving a new voice message. If someone leaves you a voice mail, you will receive a message waiting indicator. MWI will be indicated in three ways: a warning tone, an indicator message (including a voice mail icon) on the LCD screen, and the power indicator LED slowly flashes red. This will be cleared when you retrieve all voice mails or delete them.

The MWI service is unsolicited for some servers, so the SIP-T46S IP phone only handles the MWI messages sent from the server. But for other servers, the MWI service is solicited, so the SIP-T46S IP phone must enable subscription for MWI.

**Note**

MWI service is not available on all servers. Contact your system administrator for more information.

The MWI subscription parameters you need to know:

Options	Description
<b>Subscribe for MWI</b>	Enable or disable a subscription for MWI service.
<b>MWI Subscription Period</b>	Period of MWI subscription. The IP phone sends a refresh SUBSCRIBE request before initial SUBSCRIBE expiration.
<b>Subscribe MWI To Voice Mail</b>	Enable or disable a subscription to the voice mail number for MWI service. To use this feature, you should also configure the voice mail number.

**Note**

The phone will send SUBSCRIBE messages for the MWI service to the account or the voice number MWI service depending on the server. Contact your system administrator for more information.

**To configure subscribe for MWI via web user interface:**

1. Click on **Account**->**Advanced**.
2. Select the desired account from the pull-down list of **Account**.
3. Select **Enabled** from the pull-down list of **Subscribe for MWI**.
4. Enter the period time in the **MWI Subscription Period(Seconds)** field.

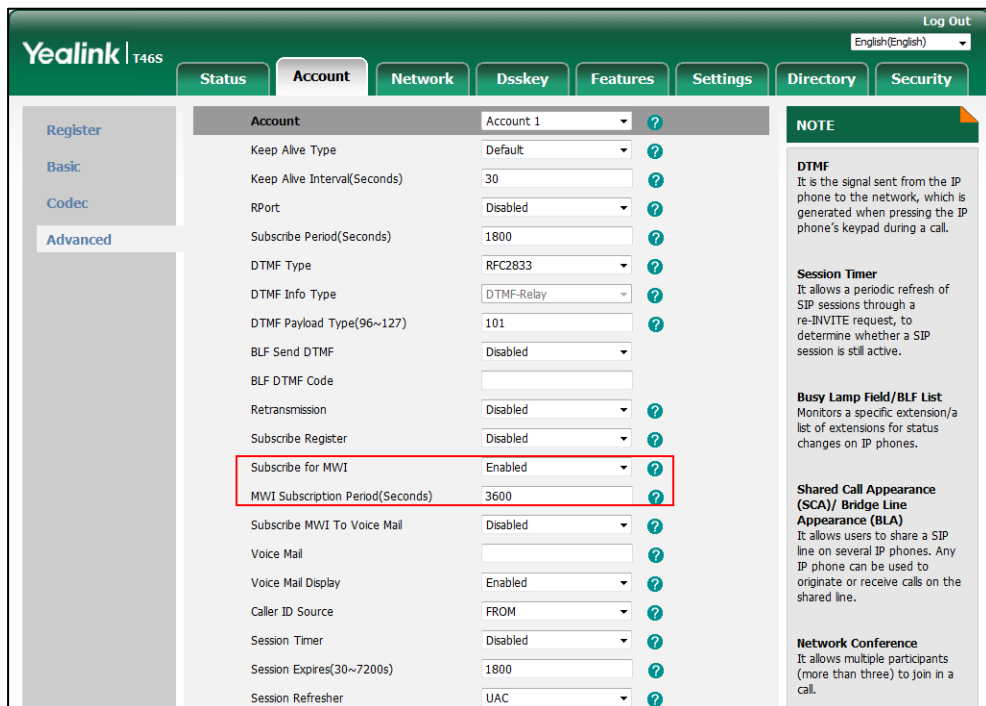

5. Click **Confirm** to accept the change.

The IP phone will subscribe to the account number for MWI service by default.



**To enable subscribe MWI to voice mail via web user interface:**

1. Click on **Account**->**Advanced**.
2. Select the desired account from the pull-down list of **Account**.
3. Select **Enabled** from the pull-down list of **Subscribe for MWI**.
4. Select **Enabled** from the pull-down list of **Subscribe MWI To Voice Mail**.
5. Enter the desired voice mail number in the **Voice Mail** field.

The screenshot shows the Yealink T46S web interface. The 'Account' tab is active, and the 'Advanced' sub-tab is selected. The 'Account' dropdown is set to 'Account 1'. The following settings are visible:

Field	Value
Keep Alive Type	Default
Keep Alive Interval(Seconds)	30
RPort	Disabled
Subscribe Period(Seconds)	1800
DTMF Type	RFC2833
DTMF Info Type	DTMF-Relay
DTMF Payload Type(96~127)	101
Retransmission	Disabled
Subscribe Register	Disabled
Subscribe for MWI	Enabled
MWI Subscription Period(Seconds)	3600
Subscribe MWI To Voice Mail	Enabled
Voice Mail	*4
Voice Mail Display	Enabled
Caller ID Source	FROM

On the right side, there is a 'NOTE' section with the following text:

**DTMF**  
It is the signal sent from the IP phone to the network, which is generated when pressing the IP phone's keypad during a call.

**Session Timer**  
It allows a periodic refresh of SIP sessions through a re-INVITE request, to determine whether a SIP session is still active.

**Busy Lamp Field/BLF List**  
Monitors a specific extension/a list of extensions for status changes on IP phones.

**Shared Call Appearance (SCA)/ Bridge Line Appearance (BLA)**  
It allows users to share a SIP line on several IP phones. Any IP phone can be used to originate or receive calls on the shared line.

6. Click **Confirm** to accept the change.

The IP phone will subscribe to the voice mail number for MWI service using Subscribe MWI To Voice Mail.

**Note**

MWI subscription is configurable via web user interface only.



---

## Regulatory Notices

---

### Service Agreements

Contact your Yealink Authorized Reseller for information about service agreements applicable to your product.

### Limitations of Liability

TO THE FULL EXTENT ALLOWED BY LAW, YEALINK EXCLUDES FOR ITSELF AND ITS SUPPLIERS ANY LIABILITY, WHETHER BASED IN CONTRACT OR TORT (INCLUDING NEGLIGENCE), FOR INCIDENTAL, CONSEQUENTIAL, INDIRECT, SPECIAL, OR PUNITIVE DAMAGES OF ANY KIND, OR FOR LOSS OF REVENUE OR PROFITS, LOSS OF BUSINESS, LOSS OF INFORMATION OR DATA, OR OTHER FINANCIAL LOSS ARISING OUT OF OR IN CONNECTION WITH THE SALE, INSTALLATION, MAINTENANCE, USE, PERFORMANCE, FAILURE, OR INTERRUPTION OF ITS PRODUCTS, EVEN IF YEALINK OR ITS AUTHORIZED RESELLER HAS BEEN ADVISED OF THE POSSIBILITY OF SUCH DAMAGES, AND LIMITS ITS LIABILITY TO REPAIR, REPLACEMENT, OR REFUND OF THE PURCHASE PRICE PAID, AT YEALINK'S OPTION. THIS DISCLAIMER OF LIABILITY FOR DAMAGES WILL NOT BE AFFECTED IF ANY REMEDY PROVIDED HEREIN SHALL FAIL OF ITS ESSENTIAL PURPOSE.

### Safety Instructions

**Save these instructions. Read these safety instructions before use!**

The following basic safety precautions should always be followed to reduce the risk of fire, electrical shock, and other personal injury.



#### General Requirements

- Before you install and use the device, read the safety instructions carefully and observe the situation during operation.
- During the process of storage, transportation, and operation, please always keep the device dry and clean.
- During the process of storage, transportation, and operation, please avoid collision and crash of the device.
- Please do not attempt to dismantle the device by yourself. In case of any discrepancy, please contact the appointed maintenance center for repair.
- Without prior written consent, no organization or individual is permitted to make any change to the structure or the safety design of the device. Yealink is under no circumstances liable to consequences or legal issues caused by such changes.
- Please refer to the relevant laws and statutes while using the device. Legal rights of others should also be respected as well.



#### Environmental Requirements

- Place the device at a well-ventilated place. Do not expose the device under direct sunlight.
- Keep the device dry and free of dust.
- Place the device on a stable and level platform.

- Please do not place heavy objects on the device in case of damage and deformation caused by the heavy load.
- Keep at least 10 cm between the device and the closest object for heat dissipation.
- Do not place the device on or near any inflammable or fire-vulnerable object, such as rubber-made materials.
- Keep the device away from any heat source or bare fire, such as a candle or an electric heater.
- Keep the device away from any household appliance with a strong magnetic field or electromagnetic field, such as a microwave oven or a refrigerator.

### **Operating Requirements**

- Do not let a child operate the device without guidance.
- Do not let a child play with the device or any accessory in case of accidental swallowing.
- Please only use the accessories provided or authorized by the manufacturer.
- The power supply of the device must meet the requirements of the input voltage of the device. Please use the provided surge protection power socket only.
- Before plugging or unplugging any cable, make sure that your hands are completely dry.
- Do not spill liquid of any kind on the product or use the equipment near water, for example, near a bathtub, washbowl, kitchen sink, wet basement or near a swimming pool.
- Do not tread on, pull, or over-bend any cable in case of malfunction of the device.
- During a thunderstorm, stop using the device and disconnect it from the power supply. Unplug the power plug and the Asymmetric Digital Subscriber Line (ADSL) twisted pair (the radio frequency cable) to avoid lightning strike.
- If the device is left unused for a rather long time, disconnect it from the power supply and unplug the power plug.
- When there is smoke emitted from the device, or some abnormal noise or smell, disconnect the device from the power supply, and unplug the power plug immediately. Contact the specified maintenance center for repair.
- Do not insert any object into equipment slots that is not part of the product or auxiliary product.
- Before connecting a cable, connect the grounding cable of the device first. Do not disconnect the grounding cable until you have disconnected all other cables.

### **Cleaning Requirements**

- Before cleaning the device, stop using it and disconnect it from the power supply.
- Use a piece of soft, dry and anti-static cloth to clean the device.
- Keep the power plug clean and dry. Using a dirty or wet power plug may lead to electric shock or other perils.

## Appendix

### Appendix A - Time Zones

Time Zone	Time Zone Name
-11	Samoa
-10	United States-Hawaii-Aleutian, United States-Alaska-Aleutian
-9:30	French Polynesia
-9	United States-Alaska Time
-8	Canada(Vancouver,Whitehorse), Mexico(Tijuana,Mexicali), United States-Pacific Time
-7	Canada(Edmonton,Calgary), Mexico(Mazatlan,Chihuahua), United States-MST no DST, United States-Mountain Time
-6	Canada-Manitoba(Winnipeg), Chile(Easter Islands), Mexico(Mexico City,Acapulco), United States-Central Time
-5	Bahamas(Nassau), Canada(Montreal,Ottawa,Quebec), Cuba(Havana), United States-Eastern Time
-4:30	Venezuela(Caracas)
-4	Canada(Halifax,Saint John), Chile(Santiago), Paraguay(Asuncion), United Kingdom-Bermuda(Bermuda), United Kingdom(Falkland Islands), Trinidad&Tobago
-3:30	Canada-New Foundland(St.Johns)
-3	Argentina(Buenos Aires), Brazil(DST), Brazil(no DST), Denmark-Greenland(Nuuk)
-2:30	Newfoundland and Labrador
-2	Brazil(no DST)
-1	Portugal(Azores)
0	Denmark-Faroe Islands(Torshavn), GMT, Greenland, Ireland(Dublin), Morocco, Portugal(Lisboa,Porto,Funchal), Spain-Canary Islands(Las Palmas), United Kingdom(London)
+1	Albania(Tirane), Austria(Vienna), Belgium(Brussels), Caicos, Chad, Croatia(Zagreb), Czech Republic(Prague), Denmark(Kopenhagen), France(Paris), Germany(Berlin), Hungary(Budapest), Italy(Rome), Luxembourg(Luxembourg), Macedonia(Skopje), Namibia(Windhoek), Netherlands(Amsterdam), Spain(Madrid)
+2	Estonia(Tallinn), Finland(Helsinki), Gaza Strip(Gaza), Greece(Athens), Israel(Tel Aviv), Jordan(Amman), Latvia(Riga), Lebanon(Beirut), Moldova(Kishinev), Romania(Bucharest), Russia(Kaliningrad), Syria(Damascus), Turkey(Ankara), Ukraine(Kyiv, Odessa)
+3	East Africa Time, Iraq(Baghdad), Russia(Moscow)
+3:30	Iran(Teheran)
+4	Armenia(Yerevan), Azerbaijan(Baku), Georgia(Tbilisi), Kazakhstan(Aktau), Russia(Samara)
+4:30	Afghanistan(Kabul)
+5	Kazakhstan(Aqtobe), Kyrgyzstan(Bishkek), Pakistan(Islamabad), Russia(Chelyabinsk)
+5:30	India(Calcutta)
+5:45	Nepal(Katmandu)
+6	Kazakhstan(Astana, Almaty), Russia(Novosibirsk,Omsk)
+6:30	Myanmar(Naypyitaw)
+7	Russia(Krasnoyarsk), Thailand(Bangkok)
+8	Australia(Perth), China(Beijing), Russia(Irkutsk, Ulan-Ude), Singapore(Singapore)
+8:45	Eucla

<b>Time Zone</b>	<b>Time Zone Name</b>
+9	Japan(Tokyo), Korea(Seoul), Russia(Yakutsk,Chita)
+9:30	Australia(Adelaide), Australia(Darwin)
+10	Australia(Brisbane), Australia(Hobart), Australia(Sydney,Melboume,Canberra), Russia(Vladivostok)
+10:30	Australia(Lord Howe Islands)
+11	New Caledonia(Noumea), Russia(Srednekolymsk Time)
+11:30	Norfolk Island
+12	New Zealand(Wellington,Auckland), Russia(Kamchatka Time)
+12:45	New Zealand(Chatham Islands)
+13	Tonga(Nukualofa)
+13:30	Chatham Islands
+14	Kiribati

## Appendix B - Menu Structure

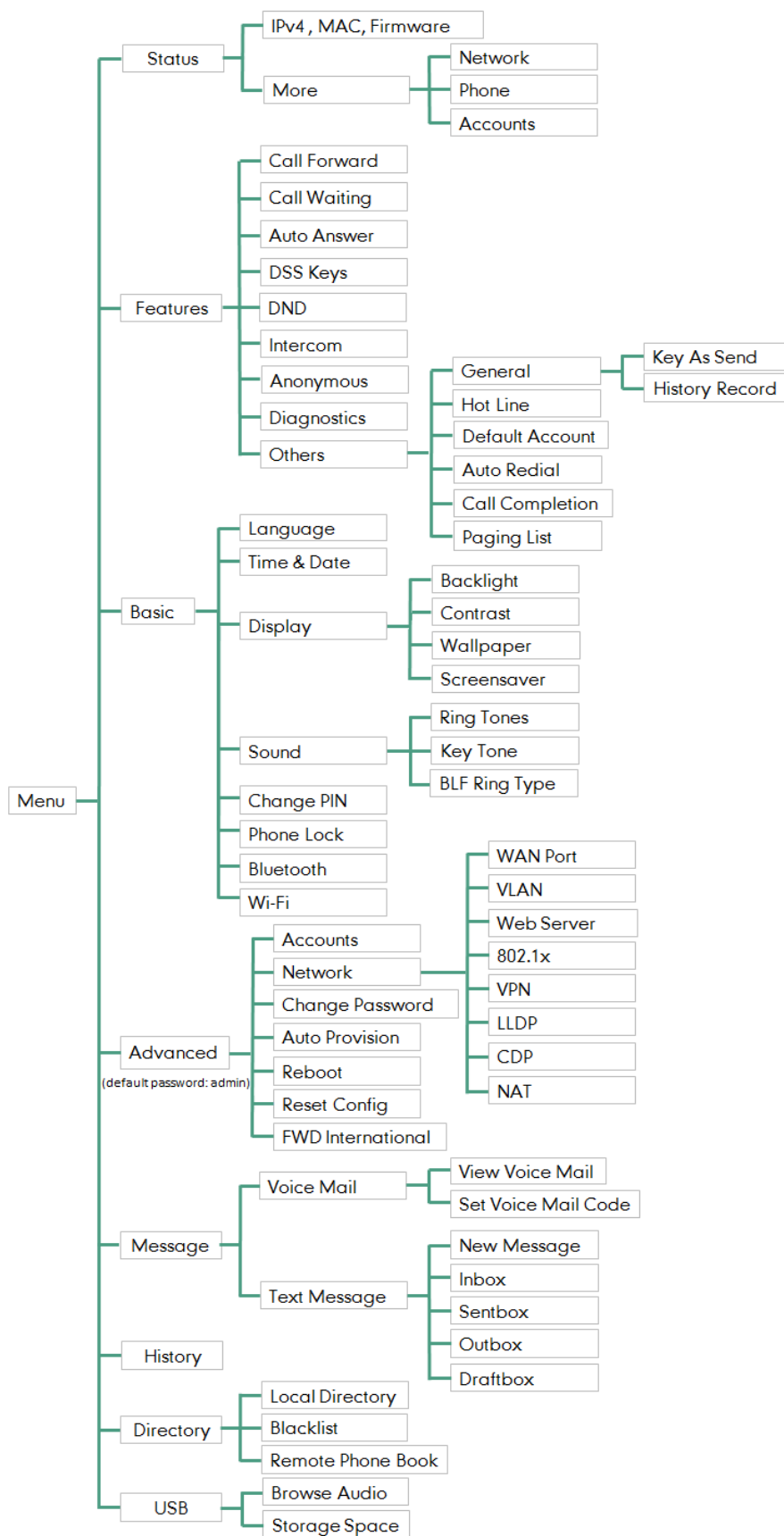





# Index

## A

About This Guide [v](#)  
 Accessing the Remote Phone Book [77](#)  
 Account Management [103](#)  
 Account Registration [103](#)  
 Activating the Bluetooth Mode [85](#)  
 Activating the Wi-Fi Mode [29](#)  
 Adding a Contact to the Local Directory/Blacklist [79](#)  
 Adding Contacts [64](#)  
 Adding Groups [61](#)  
 Administrator password [50](#)  
 Advanced Phone Features [161](#)  
 Anonymous Call [158](#)  
 Anonymous Call Rejection [159](#)  
 Answering Calls [118](#)  
 Appendix A - Time Zones [223](#)  
 Area Code [110](#)  
 Attended Transfer [144](#)  
 Audio Settings [55](#)  
 Auto Answer [121](#)  
 Auto Redial [122](#)  
 Automatic Call Distribution (ACD) [192](#)

## B

Backlight [41](#)  
 Basic Call Features [115](#)  
 Basic Network Settings [26](#)  
 Blacklist [74](#)  
 Blind Transfer [142](#)  
 BLF List [168](#)  
 Block Out [111](#)  
 Bluetooth Headset [84](#)  
 Bridged Lines Appearance (BLA) [207](#)  
 Busy Lamp Field (BLF) [161](#)

## C

Call Completion [123](#)  
 Call Forward [132](#)  
 Call History Management [78](#)  
 Call Hold/Resume [126](#)  
 Call Mute [125](#)  
 Call Park/Retrieve [148](#)  
 Call Pickup [153](#)  
 Call Recording [170](#)  
 Call Transfer [141](#)  
 Call Waiting [144](#)  
 CE Mark Warning [vi](#)  
 Conference [145](#)  
 Configuring a Record Key [177](#)  
 Configuring a URL Record Key [178](#)  
 Configuring an Access URL [76](#)  
 Configuring an Intercom Key [181](#)  
 Configuring BLA Feature on the IP Phone [208](#)

Configuring SCA Feature on the IP Phone [195](#)  
 Configuring the Intercom Feature on the IP Phone [181](#)  
 Connecting to the Wired Network [24](#)  
 Connecting to the Wireless Network [29](#)  
 Contact Management [58](#)  
 Contrast [47](#)  
 Copyright [vi](#)  
 Customizing Your Phone [39](#)

## D

Deactivating the Bluetooth Mode [89](#)  
 Deactivating the Wi-Fi Mode [34](#)  
 Declaration of Conformity [vi](#)  
 Deleting Contacts [67](#)  
 Deleting Groups [63](#)  
 Deleting History Records [79](#)  
 Deleting the Paired Bluetooth Headset [88](#)  
 Dial Now [108](#)  
 Dial Plan [106](#)  
 Directory [59](#)  
 Disabling History Record [80](#)  
 Disconnecting the Bluetooth Headset [88](#)  
 Disconnecting the Wireless Network Connection [33](#)  
 Do Not Disturb (DND) [128](#)  
 Documentation [15](#)  
 DSS Keys [89](#)  
 Dual Headset [83](#)  
 Dynamic Forwarding [141](#)

## E

Editing Contacts [66](#)  
 Editing Groups [62](#)  
 Editing Device Information [87](#)  
 Emergency Number [112](#)  
 Ending Calls [119](#)  
 Entering Data and Editing Fields [36](#)

## F

Feature Status Icons [3](#)

## G

General Settings [39](#)  
 Getting Started [17](#)

## H

Hardware Component Instructions [1](#)  
 Headset Mode Activation/Deactivation [82](#)

Headset Prior [83](#)  
 Headset Use [82](#)  
 Hotline [113](#)  
 Hot Desking [179](#)

## I

Icon Instructions [3](#)  
 Idle Screen [35](#)  
 Importing/Exporting Contact lists [72](#)  
 In This Guide [v](#)  
 Incoming Intercom Calls [181](#)  
 Intercom [180](#)

## K

Key As Send [51](#)  
 Key Tone [58](#)

## L

Label Length [92](#)  
 Language [47](#)  
 LED Instructions [5](#)  
 Limitation of Liability [221](#)  
 Line Key Icons [4](#)  
 Line Keys [89](#)  
 Line Key Features [94](#)  
 Live Dialpad [113](#)  
 Local Conference [145](#)  
 Local Directory [61](#)

## M

Manually Add a Wireless Network [32](#)  
 Manually Connect to an Available Wireless Network [30](#)  
 Message Waiting Indicator (MWI) [217](#)  
 Messages [213](#)  
 Multicast Paging [183](#)  
 Multiple Line Keys per Account [105](#)  
 Music on Hold [191](#)  
 Muting a Call [126](#)  
 Muting While Dialing [126](#)

## N

Network Conference [147](#)  
 Network Connection [23](#)

## O

Optional Accessories [18](#)  
 Other Icons [8](#)  
 Overview [1](#)

## P

Packaging Contents [17](#)  
 Pairing and Connecting the Bluetooth Headset [85](#)

Phone Initialization [23](#)  
 Phone Installation [20](#)  
 Phone Lock [52](#)  
 Phone Status [25](#)  
 Phone User Interface [12](#)  
 Picking up an Incoming Call of the Target Extension [183](#)  
 Placing a Call from History Records [79](#)  
 Placing an Intercom Call to the Target Extension [183](#)  
 Placing Calls [115](#)  
 Placing Calls to Contacts [70](#)  
 Power Saving [43](#)  
 Programable Keys [101](#)

## R

ReCall [125](#)  
 Receiving RTP Stream [188](#)  
 Recent Call In Dialing [119](#)  
 Recording a Call [178](#)  
 Recording Using USB Flash Drive [171](#)  
 Recording Using a Record Key [176](#)  
 Redialing Numbers [119](#)  
 Registration [28](#)  
 Regulatory Notices [221](#)  
 Remote Phone Book [76](#)  
 Replace Rule [107](#)  
 Ring Tones [56](#)

## S

Safety Instructions [221](#)  
 Search Source List in Dialing [80](#)  
 Searching for Contacts [71](#)  
 Semi-attended Transfer [143](#)  
 Sending RTP Stream [184](#)  
 Service Agreements [221](#)  
 Screen Saver [41](#)  
 Short Message Service (SMS) [213](#)  
 Shared Call Appearance (SCA) [194](#)  
 Static Forwarding [133](#)  
 System Customizations [80](#)

## T

Table of Contents [vii](#)  
 Time & Date [48](#)

## U

User Interfaces [11](#)  
 Using BLA Features on the IP Phone [211](#)  
 Using Intercom [183](#)  
 Using Multicast Paging [190](#)  
 Using SCA Features on the IP Phone [201](#)

## V

Viewing History Records [78](#)  
 Viewing the Bluetooth Headset Information [87](#)

Viewing the Wireless Network Information

[32](#)

Voice Mail [215](#)

Volume [55](#)

## **W**

Warranty [vi](#)

Wallpaper [39](#)

Web User Interface [12](#)

WEEE Warning [vii](#)

Wi-Fi Protected Setup (WPS) [31](#)

Wireless Network Settings [28](#)